

## Air Data Test Set

# CPA8001





**This Warning symbol indicates that danger of injury for persons and the environment and/or considerable material damage (mortal danger, danger of injury) will occur if the respective safety precautions are not taken.**



**This Caution symbol indicates danger for the system and material if the respective safety precautions are not taken.**



**This Notice symbol does not indicate safety notices but information for a better understanding of the facts**

## Table of Contents

<b>1. General Information</b>	<b>7</b>
1.1 Warranty	7
1.2 Important Notice	7
1.3 FCC Radio Frequency Emission Notice	7
1.4 Trademarks and Copyrights	8
1.5 Software License Agreement	8
1.6 Mensor Service Plus	8
1.6.1 After the Warranty	8
1.6.2 Calibration Services	9
1.6.3 Accreditations	9
1.7 Packaging for Shipment	9
<b>2. Safety Notices</b>	<b>10</b>
2.1 User Responsibilities	10
2.2 General Safety Notices	10
2.3 Warnings and Caution Notices	11
<b>3. Product Description</b>	<b>12</b>
3.1 General Description	12
3.2 IntelliScale Transducer Choices	12
3.3 Front Panel	13
3.3.1 Power Switch	13
3.3.2 USB Port	13
3.3.3 Information Label	13
3.3.4 Screen	13
3.3.5 Main Screen Features	14
3.3.5.1 Screen Navigation	14
3.4 Main Features	15
<b>4. Specifications</b>	<b>16</b>
4.1 Measure Specifications	16
4.2 Control Specifications	17
4.3 General Specifications	17
4.4 Transducer Removal/Replacement	18
4.5 Regulator	19
4.6 Transducer Module	19
4.7 IntelliScale	20
<b>5. Installation</b>	<b>21</b>
5.1 Initial Installation	21
5.2 Unpacking the System	21

5.3 Dimensions (inches)	22
5.4 Turning on the CPA8001	23
5.5 Pressure Connections	23
5.6 Pneumatic Connections and Pressure Fittings	25
5.7 Electrical & Communication Connections	26
5.7.1 Notices Regarding the Electrical Connections	27
5.7.1.1 Power Supply	27
5.7.1.2 Interfaces	27
5.7.1.3 Ethernet Interface	27
5.7.1.4 USB Host Interface	27
5.7.1.5 USB Device Interface	27
5.7.1.6 RS-232 Interface	27
5.7.1.7 IEEE-488 Interface	27
<b>6. Local Operation</b>	<b>28</b>
6.1 General	28
6.1.1 Buttons, Keys, Switches, Tabs, and Other Terms	29
6.1.2 Map of the Main Screen Features	29
6.2 Main Screen Buttons / Features	30
6.2.1 CPA8001 Air Data Test Set Configuration Options: Ps/Pt or Ps/Qc	31
6.2.2 Avionics / Pressure Reading	31
6.2.3 Setpoint Buttons	32
6.2.4 Setpoint Value	32
6.2.5 Setup	33
6.2.6 Setpoint Entry Methods	33
6.2.6.1 Number Pad	34
6.2.6.2 Number Pad / Step	35
6.2.6.3 Digital Step	35
6.2.6.4 Program Data Entry	36
6.2.7 Favorites	37
6.2.8 Status Bar	37
6.2.9 Secondary Display	38
6.2.10 Limits	39
6.2.11 Instrument Modes / Avionics Units / Pressure Units	40
6.2.12 Pressure Type	40
6.2.13 Operating Modes	41
6.2.13.1 Measure Mode	42
6.2.13.2 Control Mode	44
6.2.13.3 Vent Mode	46

6.2.13.4 State of the Isolation Valves when the CPA8001 is off	48
6.2.14 Vacuum Setting	49
6.2.15 Automated Zero	50
<b>7. Setup</b>	<b>52</b>
7.1 General Tab	53
7.1.1 Instrument Mode	53
7.1.2 Linked Modes	54
7.1.3 Language	54
7.1.4 Brightness	55
7.1.5 Volume	55
7.1.6 Zero Reminder Interval	56
7.1.7 Save [Configuration]	56
7.1.8 Load [Configuration]	57
7.2 Remote Tab	58
7.2.1 Remote Command Set	58
7.2.2 IEEE-488 Address	58
7.2.3 Ethernet Communication	59
7.2.4 Termination Character	59
7.2.5 Serial Communications	60
7.3 Channel Setup [Ps], [Pt] and [Qc]	61
7.3.1 Setup Units	62
7.3.2 Rate Units	62
7.3.3 Secondary Display	63
7.3.4 Secondary Display Units	63
7.3.5 Filter	64
7.3.6 Resolution	64
7.3.7 Negative Qc Limits	65
7.3.8 Qc Reference	66
7.3.9 True Airspeed Enable	67
7.3.10 True Airspeed Temperature	67
7.3.11 Maximum Limits and Minimum Limits	68
7.3.12 Stable Limits and Stable Delay	69
7.3.13 Rate Maximum Limits and Rate Minimum Limits	71
7.3.14 Rate Stable Limits and Rate Stable Delay	72
7.3.15 Vent Rate (Go-To-Ground parameters)	73
7.4 Applications	74
7.4.1 Passwords	75
7.4.2 Calibration - Guidelines	76

7.4.2.1	Calibration Environment	76
7.4.2.2	Calibration Pressure Standards	76
7.4.2.3	Calibration Media	76
7.4.2.4	Calibration Setup	77
7.4.3	Calibration Procedures	78
7.4.3.1	1 Point Calibration	79
7.4.3.2	2 Point Calibration	82
7.4.3.3	Linearize	83
7.4.4	Programs	86
7.4.5	Favorites	87
7.4.6	Troubleshoot	87
7.4.7	Admin	88
7.5	Info Tab	88
<b>8.</b>	<b>Remote Operation</b>	<b>89</b>
8.1	Software/Functions	89
8.2	Remote Command Set	89
8.3	SCPI Commands	97
8.4	SCPI Error Messages and Error Codes	101
<b>9.</b>	<b>Options</b>	<b>102</b>
9.1	Transport Case	102
9.2	Rack Mount Kit	102
9.3	Barometric Reference Transducer	102
9.4	Adaptor Fittings	103
<b>10.</b>	<b>Maintenance</b>	<b>103</b>
10.1	Beyond the Warranty	103
10.2	Troubleshooting	103
10.2.1	Pressure Transducer Location	105
10.2.2	Transducer Removal / Replacement	105
<b>11.</b>	<b>Appendix</b>	<b>107</b>
11.1	Avionics Overview	107
11.2	Measurement Units	108
11.3	Conversion Factors, bar	109
11.4	Conversion Factors, PSI	110
11.5	Conversion Factors, millitorr	111

## 1. General Information

### 1.1 Warranty

All products manufactured by Mensor LP (Mensor) are warranted to be free of defects in workmanship and materials for a period of two years from the date of shipment. No other express warranty is given, and no affirmation of Seller, by words or actions, shall constitute a warranty. SELLER DISCLAIMS ANY IMPLIED WARRANTIES OF MERCHANTABILITY OR FITNESS FOR ANY PARTICULAR PURPOSES WHATSOEVER. If any defect in workmanship or material should develop under conditions of normal use and service within the warranty period, repairs will be made at no charge to the original purchaser, upon delivery of the product(s) to the factory, shipping charges prepaid. If inspection by Mensor or its authorized representative reveals that the product was damaged by accident, alteration, misuse, abuse, faulty installation or other causes beyond the control of Mensor, this warranty does not apply. The judgment of Mensor will be final as to all matters concerning condition of the product, the cause and nature of a defect, and the necessity or manner of repair. Service, repairs or disassembly of the product in any manner, performed without specific factory permission, voids this warranty.

MENSOR MAKES NO WARRANTY OF ANY KIND WITH REGARD TO THIS MANUAL, INCLUDING, BUT NOT LIMITED TO, THE IMPLIED WARRANTIES OF MERCHANTABILITY AND FITNESS FOR A PARTICULAR PURPOSE. Mensor shall not be liable for errors contained herein or for incidental or consequential damages in connection with the furnishing, performance, or use of this material.

### 1.2 Important Notice



The product specifications and other information contained in this manual are subject to change without notice.

Notice

Any reproduction of this manual or parts thereof by any means is prohibited.

### 1.3 FCC Radio Frequency Emission Notice

This equipment has been tested and found to comply with the limits for a Class A digital device, pursuant to Part 15 of the FCC Rules. These limits are designed to provide reasonable protection against harmful interference when the equipment is operated in a commercial environment. This equipment generates, uses, and can radiate radio frequency energy and, if not installed and used in accordance with the instruction manual, may cause harmful interference to radio communications. Operation of this equipment in a residential area is likely to cause harmful interference in which case the user will be required to correct the interference at his or her own expense.

Use shielded cables to connect external devices to this instrument to minimize RF radiation.

## 1.4 Trademarks and Copyrights

WIKA is a registered trademark of WIKA Alexander Wiegand SE & Co. KG.  
Mensor is a registered trademark of Mensor LP. ©2012, Mensor LP. All rights reserved.



Notice

All other brand and product names are trademarks or registered trademarks of their respective companies.

## 1.5 Software License Agreement

This product contains intellectual property, i.e., software programs, that are licensed for use by the end user/customer (hereinafter “end user”).

This is not a sale of such intellectual property. The end user shall not copy, disassemble, reverse engineer or de-compile the software programs.



Notice

The software programs are provided to the end user “as is” without warranty of any kind, either express or implied, including, but not limited to, warranties of merchantability and fitness for a particular purpose. The entire risk of the quality and performance of the software program is with the end user.

Mensor and its suppliers shall not be held to any liability for any damages suffered or incurred by the end user (including, but not limited to, general, special, consequential or incidental damages including damages for loss of business profits, business interruption, loss of business information and the like), arising from or in connection with the delivery, use or performance of the software program.

## 1.6 Mensor Service Plus

Mensor has made a concerted effort to provide complete and current information for the proper use of the equipment. If there are questions regarding this manual, proper use of the equipment, or if you have problems using your CPA8001 and you don't find the answer in this manual, contact either Mensor or WIKA for personal assistance. We are ready to help.

Mensor  
201 Barnes Drive  
San Marcos, Tx 78666  
tel: 1-512-396-4200  
1-800-984-4200 (USA only)  
fax: 1-512-396-1820  
email: sales@mensor.com  
tech.support@mensor.com  
website: www.mensor.com

WIKA Alexander Wiegand SE & Co. KG  
Alexander-Wiegand-Straße 30  
63911 Klingenberg / Germany  
tel: +49 9372/132-5015  
fax: +49 9372/132-8767  
email: CTSales@wika.de  
CTService@wika.de  
website: www.wika.de

### 1.6.1 After the Warranty

Mensor's concern with the performance of this instrument is not limited to the warranty period. We provide complete repair, calibration and certification services after the warranty for a nominal fee as explained in [Section 10. Maintenance](#).



### 1.6.2 Calibration Services

In addition to servicing our own products, Mensor provides complete pressure calibration services up to 20,000 psi for many pressure instruments. This service includes a Certificate of Compliance and Calibration and a record of traceability to the pressure standards of the United States National Institute of Standards and Technology (NIST).

### 1.6.3 Accreditations

Mensor is registered to ISO 9001:2008. The calibration program at Mensor is accredited by A2LA, as complying with both the ISO/IEC 17025:2005 and the ANSI/NCSL Z540-1-1994 standards.

### 1.7 Packaging for Shipment

If the product must be shipped to a different location or returned for any reason through a common carrier it must be packaged properly to minimize the risk of damage.

The recommended method of packing is to place the instrument in a container, surrounded on all sides with at least four inches of shock attenuation material such as styrofoam peanuts.

If the instrument will be subjected to frequent transport then the optional Transport Case shown in [Section 9, Options](#), might be an economical solution. This wheeled case is very rugged and provides complete and long term protection against rough handling.

## **2. Safety Notices**

### **2.1 User Responsibilities**

To ensure safety, the operator must make sure that the following conditions are met:

- The system is used properly, no dangerous media are used and that all technical specifications are observed.
- The system is in perfect operating condition.
- The operation manual is legible and accessible to the user at the system's location.
- The system is operated, serviced and repaired only by authorized and qualified personnel.
- The user receives instruction on industrial safety and environmental protection, and is knowledgeable of all operating instructions and safety notices relevant to the current procedure.

### **2.2 General Safety Notices**



**Notice**

The system should be operated only by trained personnel who are familiar with this manual and the operation of the instrument.



**Warning**

**A condition for trouble-free and safe operation of this system is proper transport, proper storage, installation, assembly and proper use as well as careful operation and maintenance.**

**Any operation not described in the following instructions should be prohibited. The system must be handled with care required for an electronic precision instrument (protect from humidity, impacts, strong magnetic fields, static electricity and extreme temperatures). Do not insert any objects into the instrument.**

**The system is powered via the power cable with a voltage that can cause physical injury. Even after disconnecting the system from the power supply, dangerous voltages can temporarily occur due to capacitance.**

**The use of hazardous or toxic media is prohibited.**

**Repairs must be performed only by authorized service personnel.**



**Notice**

Additional safety notices are found throughout this manual.

## 2.3 Warnings and Caution Notices



**WARNING: HIGH PRESSURE!** High pressure gases are potentially hazardous. Energy stored in these gases can be released suddenly and with extreme force. High pressure systems should be assembled and operated only by personnel who have been trained in proper safety practices.



**WARNING: POSSIBLE INJURY!** The tubing, valves and other apparatus attached to the instrument must be adequate for the maximum pressure which will be applied, otherwise physical injury to the operator or bystanders is possible.



**CAUTION:** Use the proper pressure medium. Use only clean, dry, noncorrosive gases. This instrument is not designed for oxygen use.



**WARNING: NOT EXPLOSION PROOF!** Installation of this instrument in an area requiring devices rated as intrinsically safe is not recommended.



**CAUTION: ESD PROTECTION REQUIRED.** The proper use of grounded work surfaces and personal wrist straps are required when coming into contact with exposed circuits (printed circuit boards) to prevent static discharge damage to sensitive electronic components.



**WARNING:** Detachable main power supply cord with inadequate ratings should not be used. See Section 4.0, Specifications, for power supply ratings.



**WARNING:** The calculation from the current  $P_s$  and  $Q_c$  pressure becomes theoretical for the engineering unit Mach, above Mach 6. Use the Mach values above Mach 6 at your own risk.

Additional Warning and Caution notes are included throughout this manual.

### **3. Product Description**

#### **3.1 General Description**

The CPA8001 Air Data Test Set has the following features:

- 19" rack mount compatibility
- Designed for serviceability and reliability
- Wide screen display with glass capacitive touchscreen
- Front panel door gives access to instrument interior
- A Ps/Pt or Ps/Qc transducer package ([Appendix 11.1](#) gives an overview of altitude and airspeed avionics terminology and hardware.)
- Dual channel control of altitude/altitude rate and air speed/airspeed rate (air data mode)
- Dual Channel control of pressure and pressure rates (pressure mode)
- Adaptive control algorithm
- Automated Zero adjustment sequence using internal high accuracy reference transducer
- Ethernet, RS-232, USB, and IEEE-488 communications
- Remote communication emulation of Mensor legacy products
- Emulation of competitive instrument command sets
- Local program capability
- Multiple language support
- On board diagnostic logging
- Barometric reference option
- High Accuracy
- Complies with latest CE and 61010 regulations

The CPA8001 Air Data Test Set is designed to automate the testing and calibration of avionics altitude and airspeed instruments. A unique single package dual transducer, removable / interchangeable module containing Ps/Qc or Ps/Pt transducers is included. This transducer module is configured with its own calibration parameters on board.

This unique Transducer set, in combination with the internal control valve regulator, provide a dynamic output. The operator can choose to control in air data mode or in pressure mode. Transducer pressure ranges can be chosen to fit specific altitude and airspeed requirements.

A barometric transducer is available as an option for reference indication of atmospheric pressure.

#### **3.2 IntelliScale Transducer Choices**

The CPA8001 is supplied with IntelliScale Transducers. Refer to [Section 4 Specifications](#), for a full description of the uncertainty specification and [Section 4.7 IntelliScale](#).

### 3.3 Front Panel

The front of the CPA8001 has a smooth, uncluttered appearance. Its main feature is the large color display plus an identification label in the lower right corner of the display panel. The display panel is hinged for easy access to remove or replace the transducer modules inside. The instructions for accessing the transducers are provided in [Section 10.2.2, Transducer removal/replacement](#). Immediately to the right of the display panel is a USB port and a power switch.



Figure 3.3 - Front View

#### 3.3.1 Power Switch

The power switch is a two-state device with an action similar to that of a ball point pen. Push the button with enough force to latch it in to turn the unit ON. Push it again to release it to turn the system OFF.



If power to the instrument is interrupted while ON it will shut down until the power is restored, **then immediately resume operation.**

#### 3.3.2 USB Port

The front panel USB port is a Host port like the USB port on the rear panel. Both are intended for future expansions or software upgrades

#### 3.3.3 Information Label

The front panel label identifies the installed transducer ranges in the pressure units specified by the customer, the serial number and tag number.

#### 3.3.4 Screen

The large (9 inch diagonal) LCD color screen has a glass capacitive touch screen for navigation within the intuitive operator interface. At power up the main screen is presented. (See figure 3.3.5).

**3.3.5 Main Screen Features**

On power up, the main screen will show a numeric data entry key pad in the center of the display, Ps channel on the left and Qc or Pt channel on the right. The data entry key pad can be switched between 4 different methods for data entry. See Section 6, Local Operation, for more details.



**Appendix 11.1 gives an overview of altitude and airspeed avionics terminology and hardware and includes definitions of Ps, Pt and Qc.**

Notice

The Ps (left) and Qc or Pt (right) screen sections (See figure 3.3.5) contain the transducer readings, setpoints, current display configuration, range limits and labels (see [Section 6, Local Operation](#), for more details). Avionics or pressure calibration and testing functions are performed through Interaction with this screen; the majority of an operator’s local operation time will be spent working with this screen. A map of the individual features on the various displays is included in [Section 6.1.2](#).

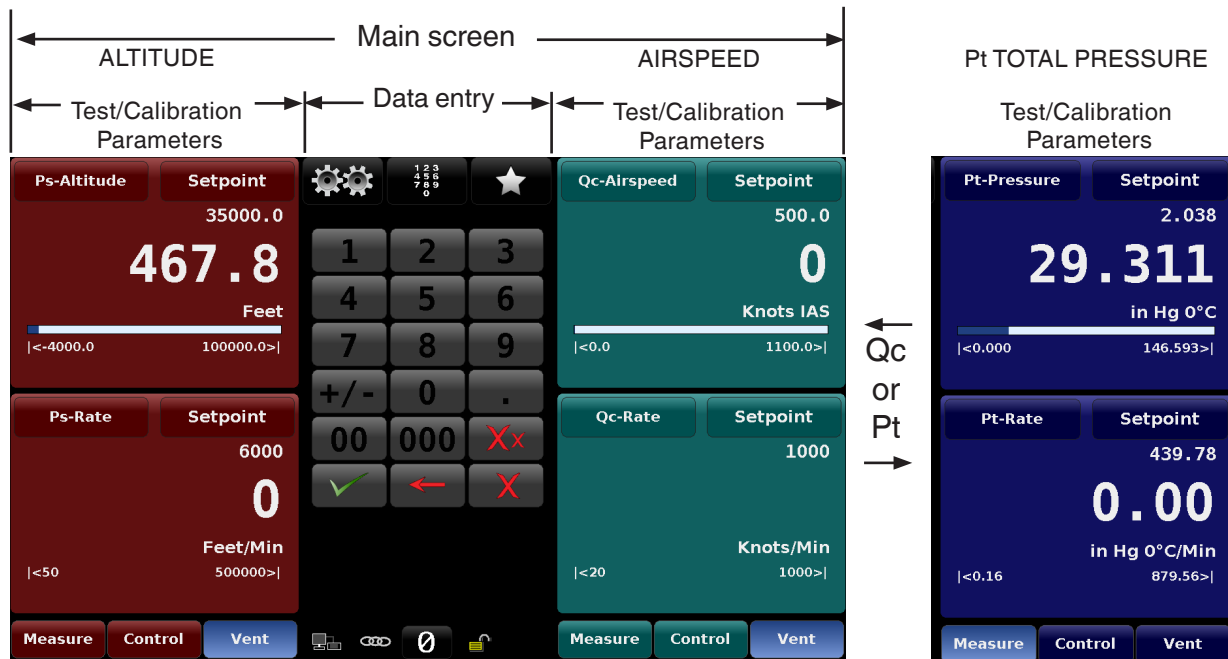

**Figure 3.3.5 - Main Screen Features**

**3.3.5.1 Screen Navigation**

Individual screens are accessed or opened by a series of touches on tabs, buttons or icons. Nomenclature that designates a screen and how to navigate to it will be given in this manual in the following structure: “Icon name” [Icon Graphic] / [Tab] / [Button Name].

For example the screen used to set the resolution of the Ps transducer would be designated by the navigational screen hierarchy, starting from the main screen, as follows: **Setup** [  ] / [Ps] / [Resolution]. This convention is similar to a computer folder system and will be used to designate a screen and, inherently, how to navigate to it.

All of the setup screens have two display areas. The left 2/3 of the screen shows information about test and calibration parameter being adjusted. The left 1/3, data entry section, has the number key pad, variable sliders or discrete choice buttons (radio buttons) that all act to input alpha numeric information or mode changes relating to the test or calibration information being shown on the left.

Buttons on the screen are shown with a gradient background. When inactive the buttons are shown with the gradient dark on the bottom and light on the top; when selected the button changes color and is light on the bottom and dark on the top. Buttons are labeled in an intuitive fashion and when selected its function is obvious.

The setup screens are accessed by pressing the double gear icon [  ]. These setup screens are used for a variety of instrument settings including, general display settings, Ps, Qc or Pt settings, and remote interface settings. This area also contains the application used to calibrate the internal transducers plus various administrative, information and configuration settings. Detailed information about all setup screens can be found in [Section 7, Setup](#).

Touch the left pointing arrow [ ◀ ] in the bottom left corner of any setup screen to return to the main screen.

Full operational descriptions of all of the screens, symbols, labels and switches are provided in [Section 6, Local Operation](#).

### 3.4 Main Features

- A unique removable / interchangeable pressure module containing both Ps and Qc or Pt transducers (see [Section 10.2.2, Transducer Removal/Replacement](#)). The transducer module is a totally self-contained and includes its unique calibration data.
- True differential pressure measurement in the Qc transducer is achieved through characterization of the transducer at operational line pressures.
- IntelliScale calibrations for maximum accuracy specifications.
- A zeroing sequence that automatically adjust Ps and/or Pt transducer zero to an internal high accuracy absolute transducer, and adjusts the Qc transducer zero to atmospheric pressure.
- An optional high performance barometer module can be installed for auxiliary barometric pressure indication.
- A large 9- inch diagonal color LCD with glass capacitive touch screen for intuitive operator interface.
- Quiet precision pressure regulator.
- Multiple languages; simply touch one of the national flags on the display to instantly change the on-screen text language, and the corresponding number and date formats. For more detailed information see [Section 7.1.1, Language](#).

## 4. Specifications

### 4.1 Measure Specifications

Transducer	Range	Uncertainty Specification
<b>Ps</b>	0 ... 29.5 to 0 ... 37 (0 ... 950 to 0 ... 1253), in HgA @ 0°C (mbar)	0.009% IS-50 <sup>(1)</sup>
Measurement Uncertainty <sup>(2)</sup>		
<b>Pt</b>	0 ... 40 to 0 ... 110 (0 ... 1355 to 0 ... 3725), in HgA @ 0°C (mbar)	0.01% IS-50 <sup>(1)</sup>
Measurement Uncertainty <sup>(2)</sup>		
<b>Qc</b>	-1 ... 3 to -1 ... 100 (-34 ... 100 to -34 ... 3386), in HgD @ 0°C (mbar)	0.01% Full Span
Measurement Uncertainty <sup>(2)</sup>		
<b>Barometric reference</b>	17 to 34 (575 to 1151), in HgA @ 0°C (mbar)	
Measurement Uncertainty <sup>(2)</sup>		0.01% Reading
<b>Vacuum reference</b>	100-1000 mtorr	
Measurement Uncertainty <sup>(2)</sup>		0.4% Reading
<b>Altitude uncertainty</b>		
	<b>0.009% IS-50 Ps Transducer 0...32 in HgA</b>	<b>0.009% IS-50 Ps Transducer 0...34 in HgA</b>
	Sea level ± 2.5 ft	Sea level ± 2.5 ft
	29000 ft ± 3.4 ft	29000 ft ± 3.6 ft
	41000 ft ± 5.7 ft	41000 ft ± 6 ft
<b>Pressure uncertainty</b>		
	<b>0.009% IS-50 Transducer 0-32 in HgA</b>	<b>0.009% IS-50 Transducer 0-34 in HgA</b>
	32 ± 0.0027 in Hg	34 ± 0.0027 in Hg
	15 ± 0.0014 in Hg	15 ± 0.0015 in Hg
	5 ± 0.0014 in Hg	5 ± 0.0015 in Hg
<b>Airspeed uncertainty</b>		
	<b>0.01% FS Qc Transducer -1...32 in Hg</b>	<b>0.01% FS Qc Transducer -1...80 in Hg</b>
	250 ± 0.12 knots	250 ± 0.31 knots
	500 ± 0.05 knots	500 ± 0.13 knots
	661 ± 0.03 knots	661 ± 0.08 knots
		1000 ± 0.03 knots
<b>Compensated temperature range</b>	15 ... 45 °C	
<b>Calibration stability</b>	1 year (all transducers)	
<b>Calibration adjustment</b>	Zero adder and span multiplier, up to 11 point linearization for each transducer.	
<b>Calibration data storage</b>	Calibration data is stored on each removable transducer.	
<b>Aviation Resolution</b>	0.1 (0.1) ft (knots)	
<b>Pressure Resolution</b>	4, 5 or 6 digits (selectable)	
<b>Orientation effects (for std. and opt. Transducers)</b>	Negligible	
<b>Pressure units</b>	psi, psf, osi, ATM, inH20@4C, inH20@20C, inH20@60F, mbar, bar, Dy/cm2, pascal, hPa, kPa, MPa, inHg@0C, inHg@60F, mTorr, Torr, mmHg@0C, cmHg@0C, MHg@0C, mmH20@4C, cmH20@4C, MH20@4C, mmH20@20C, cmH20@20C, MH20@20C, MSW, ftH20@4C, ftH20@20C, ftH20@60F, inSW, ftSW, tsi, tsf, gm/cm2, kg/cm2, kg/M2, + plus 2 user defined units (multiplier from psi or pascal)	
<b>Aviation units</b>	Altitude: feet, meter, Airspeed units: knots, km/h, meter/s, mach	

(1) 0.009% IS-50 (IntelliScale-50) = 0.009% of reading from 100% to 50% of maximum pressure range and 0.009% of 50% of maximum pressure range from minimum pressure range to 50% of maximum pressure range for 365 days. See Section 4.7 IntelliScale.

(2) Measurement Uncertainty (k=2) includes hysteresis, linearity, repeatability, reference standard, drift and temperature effects over the calibrated range for the calibration interval specified, with periodic re-zeroing



## 4.2 Control Specifications

Stability of controlled pressure                      0.002 % Pressure Span

	Altitude (ft.)	Altitude Stability (+/- ft.)	Airspeed (knots)	Airspeed Stability (+/- Knots)
	Stability of Controlled Avionics Units	-1870	0.56	0
0		0.59	10	1.042
5000		0.69	20	0.540
10000		0.80	30	0.363
20000		1.11	40	0.273
30000		1.58	50	0.218
40000		2.39	60	0.182
50000		3.88	70	0.156
60000		6.28	80	0.136
65000		7.99	90	0.121
			100	0.108
			200	0.052
			300	0.033
			400	0.023
		500	0.017	
		600	0.013	
		710	0.009	

Stability of control rate                              0.05% of rate +/- 50 ft/min

Pressure control rates                                0.001% of range/sec to 10% of range/sec

Source pressure requirements [media]            Source Requirements – 10% over range of pressure transducer  
For single supply option 10% over the range of the Pt/Qc pressure transducer.  
Exhaust Requirements – Vacuum source required for any control below atmosphere. [Clean, dry air (class 3 instrument air per ISO 8753) or nitrogen]

Minimum controlled pressure                      0.05% FS or 0.025 psi over exhaust pressure, whichever is greater.

External volume recommendation                Maximum: 60 cu.in. (1000 cc)  
Minimum: 3 cu.in. (50 cc)

## 4.3 General Specifications

### Mechanical

Size	See drawing on page 2
Weight	38 lbs., 17 kg
Pneumatic interface	7/16-20 Female SAE threaded ports for Supply, Exhaust and Measure/Control ports. Hose barb for optional barometer and/or Qc reference.
Overpressure protection	Safety valves, scaled to 110% of full scale nominal range of each transducer.
Filters	40 micron, on all pressure ports except the Barometer and Qc reference.
Screen	HD color touch screen
Mounting	Handles are standard, 19 in. rack mount optional.

### Electrical & Communications

Power supply	100-120 VAC or 200-240 VAC, 50/60 Hz
Power	140 VA max
Communications interface	IEEE-488, RS-232 (null modem cable not required), Ethernet and USB

### Environmental

Warm up	60 minutes
---------	------------

# Air Data Test Set CPA8001

Operating temperature	15 to 35 °C
Storage temperature	0 to 70 °C
Operating environment	For Indoor Use Only
Operating Altitude	3,048 meters (10,000 feet)
Operating humidity	0 to 95% RH non-condensing

## Certifications

CE-mark	Conformity certificate
Calibration	Includes calibration certificate(s). The Mensor calibration laboratory is accredited in accordance with the recognized International Standard ISO/IEC 17025:2005 and also meets the requirements of ANSI/NCSL Z540-1-1994. Accreditation is by the American Association for Laboratory Accreditation (A2LA).



Warning

**WARNING!** This is class A equipment for emissions and is intended for use in industrial environments. In other environments, e.g. residential or commercial installations, it can interfere with other equipment under certain conditions. In such circumstances the operator is expected to take the appropriate measures.

## 4.4 Transducer Removal/Replacement



Caution

**When replacing transducers the CPA8001 should be turned off.**

The CPA8001 transducer package can be removed from the chassis for the purpose of calibration or to interchange transducers. Removal requires that the front be opened by loosening the captive Phillips Head screws on the right hand side of the hinged door. For more information on transducer removal/replacement see [Section 10.2.2](#) in the Maintenance section.



**Figure 4.4 - Front cut-away view showing Transducer Module**

#### **4.5 Regulator**

The CPA8001 is supplied with a needle valve regulator (NVR) that is tuned for the transducer module that is installed. A transducer module with an identical range can be interchanged with the transducer module installed. If there is a need to replace the transducer module with one of a different range consult the factory.

#### **4.6 Transducer Module**

The transducer module has two silicon transducers of type: Ps/Qc or Ps/Pt.

Table 4.6 Transducer Type / Range / Mode / Uncertainty - Calibration Stability

<b>Standard Transducer Module</b>			
<b>Type</b>	<b>Transducer Ranges</b>	<b>Mode</b>	<b>Uncertainty - Cal Stability</b>
Ps	0 ... 29.5 to 0 ... 37 inHgA	Absolute	0.009% IS-50 - 365 days
Pt	0 ... 40 to 0 ... 110 inHgA	Absolute	0.01% Full Scale - 365 days
Qc	-1 ... 3 to -1 ... 100 inHgD	Differential	0.01% Full Span - 365 days

#### 4.7 IntelliScale

IntelliScale (IS) is a “short hand” way to describe a percent of reading uncertainty specification. Or, said another way, IntelliScale is designed to further reduce the uncertainty specification. It does this by splitting the full span in two. It then defines the uncertainty of the lower portion of the span as a percent of full scale, and the uncertainty of the upper portion as a percent of reading.

For the CPA8001 the IntelliScale specification is 0.009% IS-50. This means that the lower half of the range (50% of the maximum range) has an uncertainty of  $0.009\% \times 50\%$  or 0.0045% of the maximum range. The upper half (values > 50% of the maximum range) has an uncertainty of 0.009% of the pressure reading. Thus, any pressure within the lower portion of the pressure range has a fixed number for the uncertainty (0.0045% of Maximum Range), while the uncertainty anywhere in the upper portion of the span is a sliding scale number that is a percent (0.009%) of any reading.

For example, a device with a pressure range from 0 to 32 in HgA with an IntelliScale uncertainty specification of 0.009% IS-50 will have an uncertainty of 0.0014 in Hg ( $0.009\% \times 50\% \times 32$ ) on any pressure from 0 psi to 16 in HgA, and an uncertainty of 0.009% of reading ( $0.009\% \times R$ ) for any pressure above 16 in HgA (See figure 4.6)

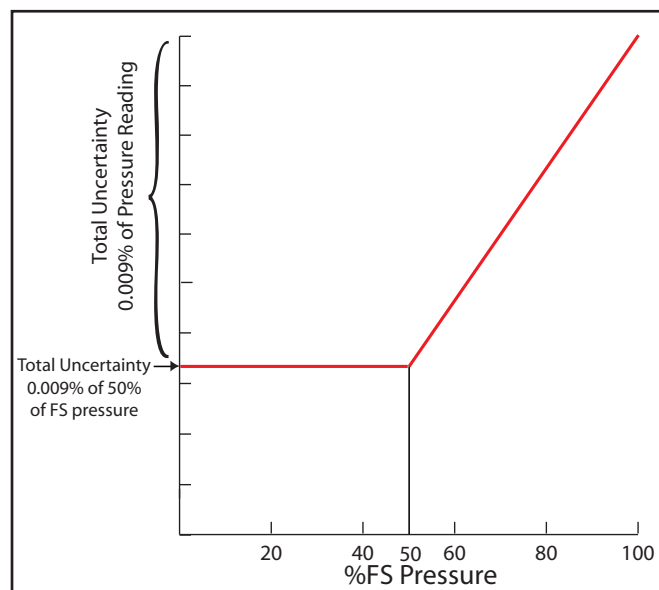

Figure 4.7 - IntelliScale IS-50

Alternatively, a Qc differential transducer with a pressure range from -1 to 32 in. HgD with % of Full Span uncertainty specification of 0.01% Full Span will have an uncertainty of 0.0033 in. Hg ( $0.01\% \times 33$ ) on any pressure from -1 psi to 32 in HgD.

## 5. Installation



**WARNING: READ THESE INSTRUCTIONS BEFORE INSTALLATION!**

The installation location must meet the following conditions (see also [Section 4, Specifications](#)):

- Ambient temperature: Compensated temperature range 15° to 45° C
- Humidity: 0-95% relative humidity, non-condensing
- Flat, horizontal location; secure fixed working surface (desk top model) or proper installation in a sturdy 19" mounting rack or cabinet
- Sufficient air circulation must be provided at the rear of the instrument to avoid accumulation of heat

Pressure Supply Requirements:

- Stable supply pressure 10% higher than the full scale of the controller
- Permissible media: Dry, clean air or nitrogen
- Vacuum: Minimum 50 liters per minute (if required)

### 5.1 Initial Installation

The initial installation of the CPA8001 includes the following steps: Unpack the system, place it in a suitable work place, connect it, switch it on and configure.

A Quick Start Guide has been placed inside the shipping box containing your instrument. This guide provides a quick reference to the pneumatic and electrical connections and an introduction to the operator interface. It is intended for experienced operators. All safety precautions within this manual should be understood and followed.

### 5.2 Unpacking the System

Your new instrument was subjected to many hours of functional testing before it left the factory. In addition to testing, the unit was inspected for appearance prior to being packaged for shipment. Upon removal from its carton please examine the instrument for shipping damage. Report any apparent damage to the carrier immediately.

Apart from any additional components ordered, a shipment consists of:

- CPA8001 Air Data Test Set
- Power Cord
- Operating Manual
- Quick Start Guide
- Any options ordered
- An envelope containing the Calibration Certificate
- A micro fiber cloth to clean the glass front panel
- Specified fittings

**5.3 Dimensions (inches)**

**DESK TOP:**

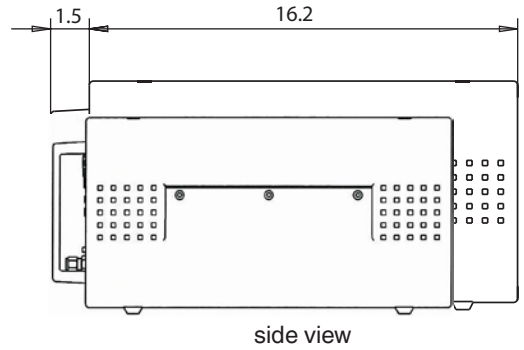
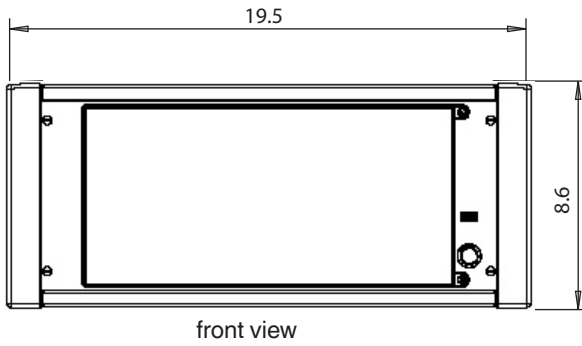

**RACK MOUNT:**

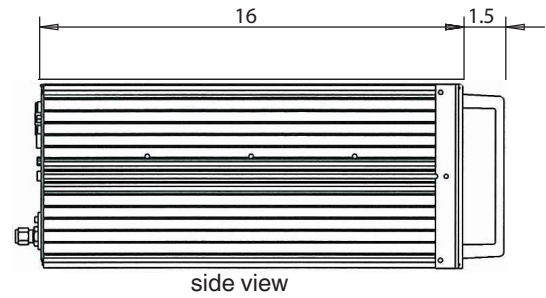
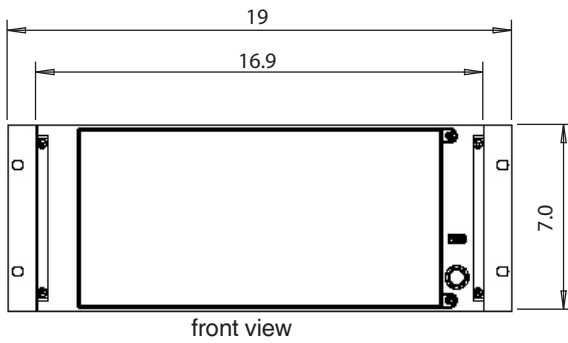

rear view

**Adaptor Fitting:**

1/4 in. Tube OD x 7/16-20 Male SAE/MS Straight Thread  
6 mm Tube OD x 7/16-20 Male SAE/MS Straight Thread

AN4 x 7/16-20 Male SAE/MS Straight Thread or  
AN6 x 7/16-20 Male SAE/MS Straight Thread

## 5.4 Turning on the CPA8001

After the pressure connections are secure in accordance with Section 5.5 below, apply power to the power connector on the rear of the instrument and switch the power switch ON. The instrument will go through an initialization process and system check. As soon as the system check is completed the system will default to an operating screen similar to the screen shown in [Section 3.3, Front Panel](#). Allow the instrument at least 60 minutes of warm up time before performing critical pressure measurements.



**Earth Ground! Any power adaptors or surge protection devices that negate the protective earth ground should not be used. The power cord must be accessible and contain a protective earth ground.**

**Ventilation! Do not block airflow to ventilating fans located on rear of instrument.**

The instrument can be set up on a table top or it can be rack mounted. Rack mount adapters are optional.

## 5.5 Pressure Connections



**Warning! The pressure connections must be installed according to the following instructions, observing the relevant regulations. The installation is to be performed by trained, authorized personnel, knowledgeable in the safety regulations for working on pneumatic systems.**



Up to 8 pressure connections are on the rear panel. Pressure connections that are not used are plugged.

Notice

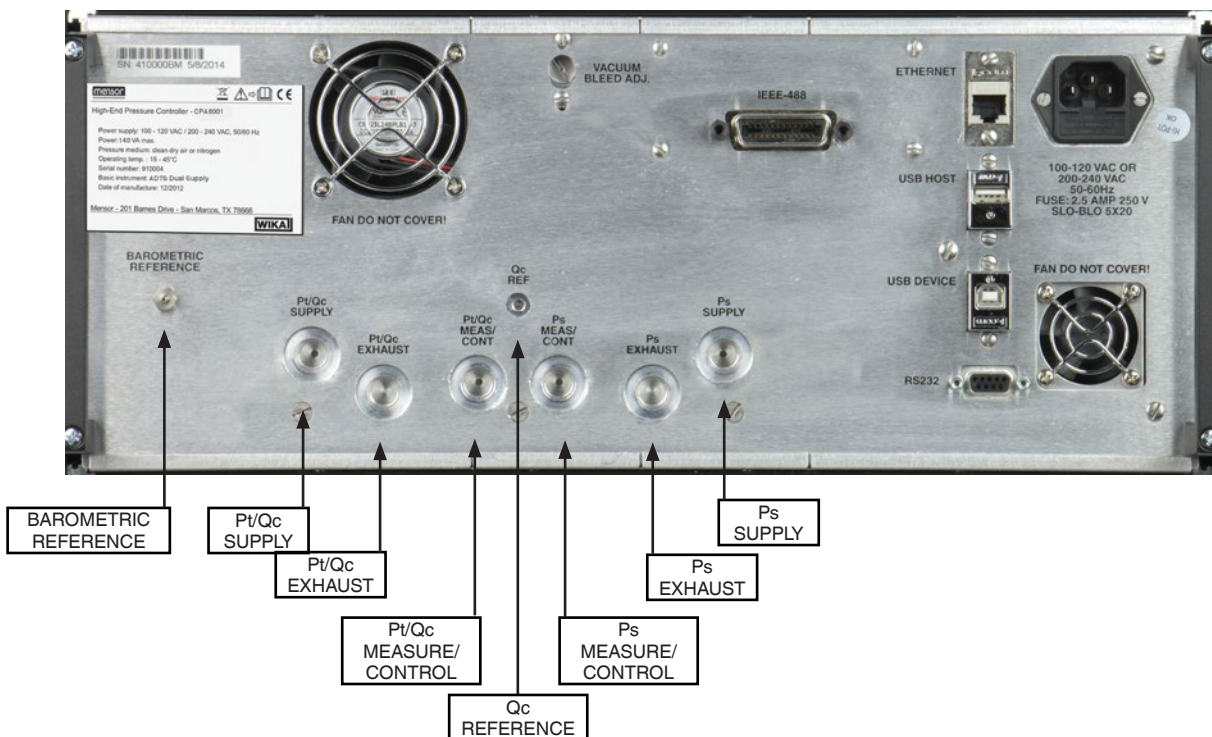

Figure 5.5 - Pressure Connections

■ **Pt/Qc or Ps Supply**

The pressure supplied to the pressure connection labeled “Supply” on either channel should be approximately 10% higher than the full scale of the pressure transducer installed in that channel. **Most CPA8001’s are supplied with an internal connection between the Pt/Qc Supply port and the Ps Supply port. In this case, the Ps supply port will be plugged and it is only necessary to connect a supply pressure to the Pt/Qc port that is 10% higher than the highest pressure in either channel.** (Pressure ranges are shown on the label on the lower right of the front panel).

■ **Pt/Qc or Ps Exhaust**

The pressure connection labeled “Exhaust” is for the vacuum supply. A separate vacuum pump (per specification) for each channel is recommended. The CPA8001 will operate with only one vacuum pump but in certain operational situations both channels may have an increased demand for a full vacuum, in this case the single vacuum pump may not have sufficient capacity to drive both channels to their set points at the commanded rates. These characteristics follow the laws of physics and apply to all Air Data Test Sets that provide the required interaction between the Ps and Qc or Pt channels.

■ **Qc Reference**

The Qc Reference is connected to the reference side (low side) of the Qc transducer through a three-way solenoid valve that is used to switch the connection to the Ps transducer. While the instrument is in Qc mode the Ps pressure and the Qc reference are connected for the common mode correction. The correction is used to remove offsets of both zero and span and the correction utilizes the Ps channel’s pressure value. While in rear panel mode the Qc reference is open to atmosphere through the rear panel. In this mode the Ps side must be seeing atmospheric pressure for an accurate Qc reading. For A Ps/Pt configuration this port would be sealed.

■ **Measure/Control**

The Measure/Control port (when in the Control mode) supplies pressure that is precisely controlled by the controller. In the Measure mode a pressure applied to the Measure/Control port is measured by the instrument transducer.

■ **Barometric Reference**

The Barometric Reference port is connected to the internal barometric transducer and should be left open to atmospheric pressure.



## 5.6 Pneumatic Connections and Pressure Fittings

The CPA8001 is supplied with 1/4 in. tube OD x 7/16-20 male SAE/MS straight thread adaptors or 6 mm tube OD x 7/16-20 male SAE/MS straight thread adaptors (per order). The 7/16-20 male SAE/MS straight thread end of the adaptors should be connected to the instrument's 7/16-20 female SAE/MS straight thread connections. The adaptors need only be "snug" for proper sealing. (When connecting the adapters connections should be made according to your specific requirements).



Notice

For functional testing and to become familiar with the operation of the CPA8001, a volume close to the volume expected during normal operation can be connected to the Measure / Control port of either channel.



Warning

**WARNING!** The user must ensure that released pressure medium does not endanger personnel, environment or the instrument.



Notice

Test items with large volumes or long piping runs with small diameter tubing can have a negative effect on the control performance.

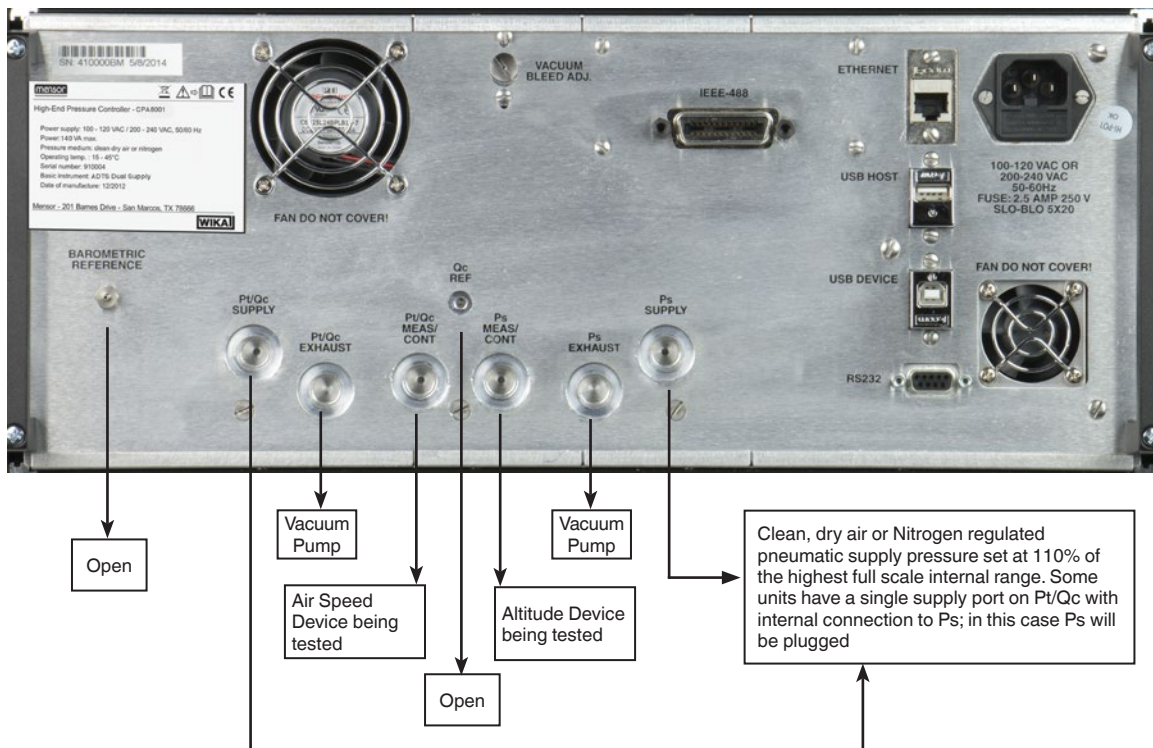

Figure 5.6 - Pneumatic Setup

**5.7 Electrical & Communication Connections**



**WARNING!** The electrical installation must be done according to the following instructions while observing the relevant regulations. It is to be performed by individuals familiar with the safety regulations for working on electrical connections.



Note: USB ports are compliant with the industry standard.

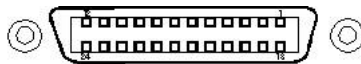

**IEEE-488.2  
24-Pin IEEE-488 Socket**

**RS-232  
9-Pin D-Sub Socket**

PIN	DESCRIPTION	PIN	DESCRIPTION
1	D101	13	D105
2	D102	14	D106
3	D103	15	D107
4	D104	16	D108
5	EOI	17	REN
6	DAV	18	GND
7	NRFD	19	GND
8	NDAC	20	GND
9	IFC	21	GND
10	SRQ	22	GND
11	ATN	23	GND
12	SHIELD	24	GND

Note:  
No Null Modem  
Required

**Figure 5.7 - Electrical Connections**

## 5.7.1 Notices Regarding the Electrical Connections

### 5.7.1.1 Power Supply



**WARNING!** Before connecting the power supply, make sure that the power voltage agrees with the voltage specification of the CPA8001. Switch off the system before connecting the power.

The 3-pin power cable supplied is fitted with a ground lead. The system should only be operated from a 3-pin socket with the ground lead properly connected.

### 5.7.1.2 Interfaces



**WARNING!** The interface cables must be separate from cables with voltages greater than 60 volts.

### 5.7.1.3 Ethernet Interface

The Ethernet jack is a standard Ethernet interface used for remote communication.

### 5.7.1.4 USB Host Interface

The USB Host interface is a service port used to upgrade software and download information from the device. It has the same function as the USB Host port on the front of the CPA8001.

### 5.7.1.5 USB Device Interface

The USB Device jack is a standard USB Type B receptacle interface used for remote communication. The USB Driver can be downloaded at [http://www.mensor.com/download\\_software\\_instrument\\_en\\_um.WIKA?ActiveID=31350](http://www.mensor.com/download_software_instrument_en_um.WIKA?ActiveID=31350)

### 5.7.1.6 RS-232 Interface

The RS-232 interface is a 9-pin D-Sub socket used for remote communication.

### 5.7.1.7 IEEE-488 Interface







The IEEE-488 interface is an IEEE-488 socket used for remote communication.

## 6. Local Operation

### 6.1 General

This section describes the procedures for operating the CPA8001 from the front panel. Instructions for operating the instrument from an external computer are covered in [Section 8, Remote Operation](#). System configuration setup parameters are explained in [Section 7, Setup](#). Pressing the Setup [  ] button gains entry into a series of setup screens for configuration of operational characteristics. Tab driven subsets of this menu provide setup choices for the general appearance, operational modes, remote communication and parameters for each channel. Sections 6, 7 and 8 are the main sections describing the operation of the unit. A Quick Start Guide is included within the instrument package for those who are familiar with the operation of precision pressure/avionics controllers. [Appendix 11.1](#) gives a brief guide to avionics terminology and the physical characteristics of air data components.

When the instrument is powered on it will take about 40 seconds to boot up. At the end of the boot process the display screen similar to figure 6.1 will appear. This is the main operating screen. At this point the CPA8001 is ready for operation. However, for critical tests and measurements allow the unit to warm up for at least 60 minutes with power on to ensure rated accuracy.

Notice that there are three distinct sections. The left side (burgundy background) contains information on the Ps - Altitude channel. The middle section (black background) contains a data entry keypad, the setup button [  ], the data entry method button [  ] and the favorites button [  ]. The right section can be either the Qc - Airspeed (green background) or the Pt - Total Pressure (blue background). This main operating screen contains output readings, setpoints, units of measure (avionics or pressure units), limits, quick access to channel configuration (example [  ]) and a choice between the control modes: Measure [  ], Control [  ] or Vent [  ] (blue shading indicates that the mode is active).

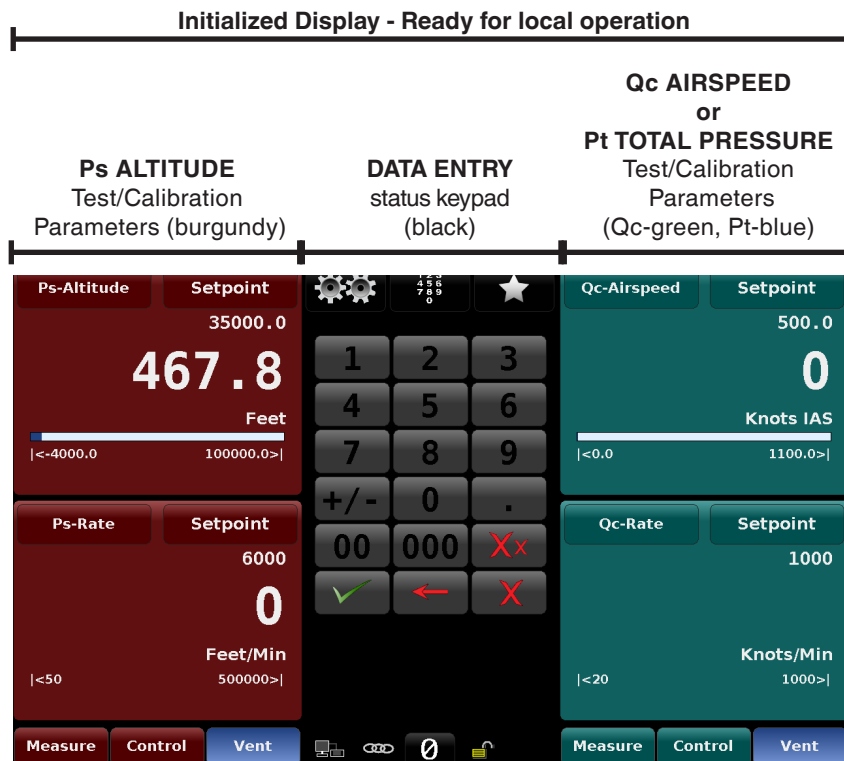

**Figure 6.1 - Initialized Display**

### 6.1.1 Buttons, Keys, Switches, Tabs, and Other Terms

Many of the words and symbols displayed on screen are active touch points, such that when touched or pressed something will change if it is an allowable action. In this manual these touch sensitive points are shown inside brackets such as [Setpoint], the button seen in the upper right corner of each section where a setpoint can be entered (See figure 6.1.2). These touch points may be referred to as a button, a key (such as a number key), a toggle switch, a radio button or a tab. Radio buttons and tabs are mutually exclusive buttons (if one in a group is chosen the others cannot be selected at the same time). Tabs are radio buttons shown along the bottom of most screens and they open other screens related to the activity named on the tab or indicate a selection associated with the active screen.

A touch point will respond with an audible “beep” as a signal of acceptance. A “blap” (error tone) sound is a signal that an illegal action was attempted, such as a number entry beyond the allowable range. A word or symbol on a screen which does NOT respond to being touched or pressed is referred to in this manual as a label, window, monitor or an indicator. A label is merely a bit of information appropriate to the displayed activity, while a window is a variable, usually a numeric value. Also, some screens will display a line or more of text messages. Labels, windows, monitors, indicators and text are not touch sensitive.

### 6.1.2 Map of the Main Screen Features

Figure 6.1.2 shows the main screen split into its functional parameter sections giving a better indication of the operational independence and functional relationship between these sections. In [Section 6.2](#) there are references to sections in this manual that explain all of these features in detail.

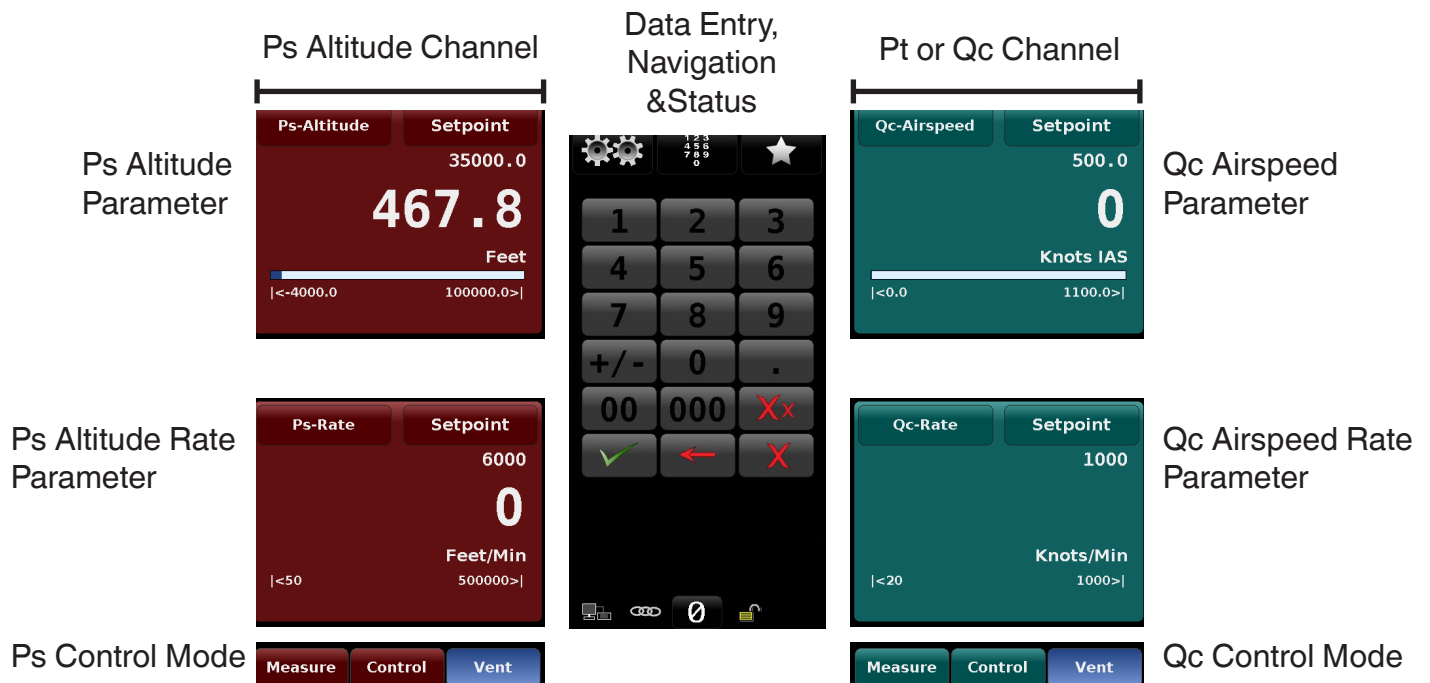











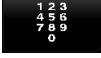





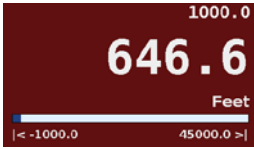

Figure 6.1.2 - Main Screen Map

**6.2 Main Screen Buttons / Features**

The table below is a reference list of the main screen buttons and their purpose and reference to sections in this manual that explain them in detail:

Table 6.2 - Reference List of the Main Screen Features

Button/ Indication	Feature	Section
	Ps-Altitude Setup	<a href="#">see 7.0 Setup</a>
	Ps-Rate Setup	<a href="#">see 7.0 Setup</a>
	Qc-Airspeed Setup	<a href="#">see 7.0 Setup</a>
	Qc-Rate Setup	<a href="#">see 7.0 Setup</a>
	Pt-Total Pressure Setup	<a href="#">see 7.0 Setup</a>
	Pt-Rate Setup	<a href="#">see 7.0 Setup</a>
	Setpoint Selection (typical for each parameter section)	<a href="#">see 6.2.3</a>
	Measure Mode (shown in active mode)	<a href="#">see 6.2.13</a>
	Control (shown in inactive mode)	<a href="#">see 6.2.13</a>
	Vent (shown in inactive mode)	<a href="#">see 6.2.13</a>
	Setup	<a href="#">see 7.0 Setup</a>
	Data entry mode key	<a href="#">see 6.2.6</a>
	Favorites	<a href="#">see 6.2.7</a>
	Check mark (accept entry)	<a href="#">see 6.2.6</a>
	Clear last digit entry	<a href="#">see 6.2.6</a>
	Clear last entry	<a href="#">see 6.2.6</a>
	Clear all pending entries	<a href="#">see 6.2.6</a>
	Setpoint indication	<a href="#">see 6.2.4</a>
	Current Reading	<a href="#">see 6.2.2</a>
	Units (avionics or pressure)	<a href="#">see 6.2.11</a>
	Bar graph & Limits	<a href="#">see 6.2.10</a>

### 6.2.1 CPA8001 Air Data Test Set Configuration Options: Ps/Pt or Ps/Qc

A **Ps/Pt** ADTS has an absolute pressure Ps channel and an absolute pressure Pt channel. In this unit Ps and Ps rate are displayed on the left side of the main screen and Pt and Pt Rate or an emulated Qc and Qc rate can be displayed on the right side.

A **Ps/Qc** ADTS has an absolute pressure Ps channel and a differential pressure Qc channel. In this unit Ps and Ps Rate are displayed on the left side of the main screen and Qc and Qc rate or an emulated Pt and Pt rate can be displayed on the right side.

### 6.2.2 Avionics / Pressure Reading

The large, green numbers displayed in figure 6.2.2 below are the altitude and Airspeed reading of the transducer connected to the respective Measure/Control ports. They are green because the sensed Altitude and Airspeed are within the user-defined stable window. When the readings is outside of the stable window, the number will be white. [See Section 7.3.9](#) for a detailed explanation and setup of the stable window. Rate indication for Altitude/Altitude rate and airspeed/airspeed rate are shown in green while stable and altitude or airspeed values are slewing to the respective control points but revert back to white as the rate decreases when approaching the Altitude or Airspeed set points.



Notice

The pressure reading will turn red if an external pressure is applied at the Measure/Control port that is 5% greater than the upper limit of the active transducer. Each transducer is supplied with a pressure release valve to protect it from over pressure. Internal safeguards are set within the software to prevent overpressure.



Figure 6.2.2 - Altitude and Airspeed Reading (shown in green)

### 6.2.3 Setpoint Buttons

Pressing any [Setpoint] button will activate the keypad (or other entry method) to accept a new setpoint value for altitude, altitude rate, airspeed or airspeed rate. The [Setpoint] button will turn yellow indicating that it is ready to accept a value. The current setpoint value is displayed in the window just below the [Setpoint] button on the main screen (see figure 6.2.4a). The setpoint value can also be adjusted incrementally by use of one of four setpoint entry methods:

- The Number Pad
- The Number Pad Step value assigned to the up [▲] and down [▼] arrow keys
- The Digital Step assigned to the up [▲] and down [▼] arrow keys
- A user defined internal Program

Procedures for making changes to the setpoint using these methods are covered in [Section 6.2.6, Setpoint Entry Methods](#).

### 6.2.4 Setpoint Value

The current setpoint value is located immediately under the [Setpoint] button for all setpoints. It displays the current pressure or avionics setpoint (target value for the output pressure provided by the internal regulator when in Control mode). To edit the setpoint value, first touch the [Setpoint] button. This will turn the setpoint button yellow. The default Number Pad or a pre-chosen setpoint entry method will become active to allow changes to the setpoint. Setpoint entry methods are described in [Section 6.2.6](#).



Figure 6.2.4a - Ps Altitude setpoint active (yellow area) - ready for setpoint entry using the number pad.

Altitude, altitude rate, air speed and airspeed rate setpoints can be activated individually or as a group. A setpoint is activated after entering it and touching the Check Mark [✓]. A setpoint entry will change to a pending state if it is entered and then the operator touches another setpoint button. All setpoints can be entered this way to set them as pending and then activated together by touching the Check Mark [✓]. Pending setpoints appear in an orange window (See figure 6.2.4b).





Figure 6.2.4b - Pending Setpoints

### 6.2.5 Setup



Press Setup [  ] to move out of the main screen and into the setup screens. Notice the bottom row of tabs and the arrow on the left end of the row (See figure 6.2.5). Each tab will bring up a screen relevant to the subject in the tab title. Touching the arrow will revert to the main operating screen.



Figure 6.2.5 - Setup Screen Tabs

From the main screen, the last visited setup screen will return if Setup [  ] is pressed again. Operational information for the setup screens is contained in [Section 7, Setup](#).

### 6.2.6 Setpoint Entry Methods

Pressing the key pad icon [  ] in the middle of the top row will display the four line menu as shown below.

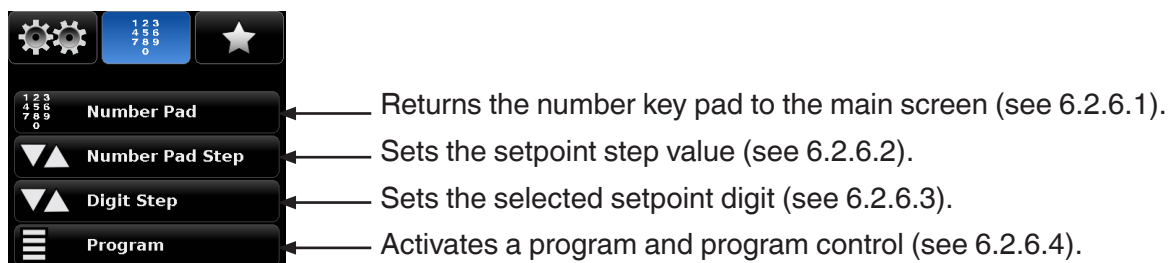

Figure 6.2.6 - Setpoint Entry Methods

### 6.2.6.1 Number Pad



The [Number Pad] button provides 10 digits for numeric entry, plus the decimal point and a sign key. This keypad becomes active when a setpoint button is touched. The sign key [+/-] will toggle between positive and negative values and can be activated at any time during the string entry. After a [Setpoint] button is selected, each key stroke on the key pad will echo within the selected (yellow background) setpoint window. Pressing the Enter [✓] key will accept the value and it will become the new Setpoint, or proceeding to another setpoint will set the value to pending (orange background).

If the input window holds an illegal value when the Enter [✓] is pressed the system will respond with an error tone and the entry will turn red. When that happens determine the cause of the rejection, and then enter a valid number.

Pressure limits are shown at the bottom of each parameter area and indicate the allowable range for entry. Limits are either set to the default limits, or the limits set for the Ps, Pt or Qc and their associated rates in the setup for each parameter. ([see Section 7](#)).

There are four action keys below the number keys that operate on the numbers displayed in the setpoint window.



Press the Enter [✓] key to accept the value showing in the setpoint window into the system for immediate use.



Press the Backspace [←] key to erase the last number entered in the string. Multiple presses will back out multiple digits.



Press the Delete [X] key to delete the entire value showing in the setpoint window to start anew, or to abort.



Press the Delete All [Xx] key to delete all values showing in every setpoint window to start anew, or to abort.

### 6.2.6.2 Number Pad / Step

The “Number Pad Step” key pad functions in two different ways:

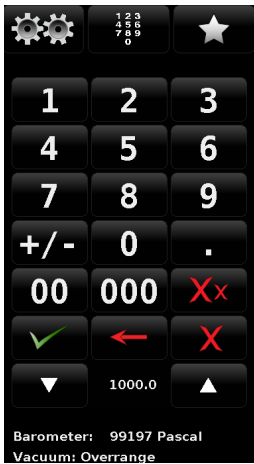

- (1) A setpoint can be entered in the same way as the Number Key Pad above: key in the number and press Enter [ ], that number is then immediately accepted into the setpoint value.
- (2) Key in a number and press the Step Up [ ] or the Step Down [ ] key, (without pressing the Enter [ ] key), that number will be used to decrease or increase the existing setpoint value.

Subsequent touches of the Step Up or Step Down key will continue to increase or decrease the setpoint by this step value until a new value is keyed in followed by a key press of the Step Up [ ] or the Step Down [ ] key. The current step value is shown between the Step Up [ ] and Step Down [ ] keys..

### 6.2.6.3 Digital Step

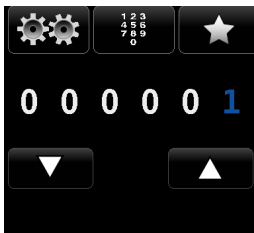

In the digital Step Data Entry Mode there is initially a string of white zeros (0) and one blue number one (1) across the top as shown in the figure to the left. The amount of digits present will correspond to the amount of resolution selected, the active units, and the selected range. Any one of these zeros can be converted to a blue 1 by touching it. Slide a finger across the zeros to demonstrate this action. Using this feature each digit of the setpoint can be increased or decreased by one digit at a time by activating the corresponding digit with a blue 1 and pressing the Up [ ] or Down [ ] key.

For example, in the screen below the Ps setpoint is at 5000.0, and the operator would like to change this to 5100.0, 5200.0, 5300.0.... and so on. He simply has to touch the digit in the Digital Step that corresponds to the “hundreds” digit in the Setpoint, thereby activating that digit and then press the Up [ ] key to increase that digit.

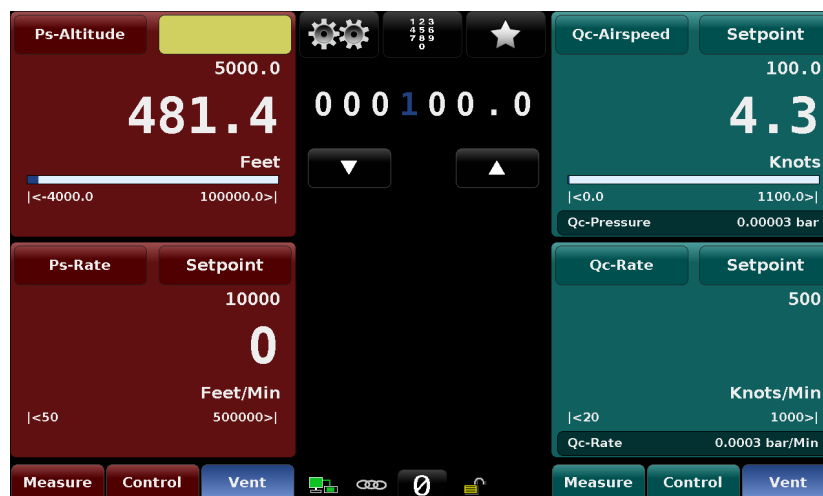



Figure 6.2.6.3 - Digital Step Screen

The number of digits available in the Step Data Entry screen will correspond to the resolution of the setpoint being changed.

### 6.2.6.4 Program Data Entry

The Program Data entry method provides an automated way to interact with the CPA8001. Most settings or processes that can be entered manually can be programmed into the unit and saved and used in the Program portion of the data entry screen. Programs are prepared and stored in the Setup [  ] / [Application] / [Program] screen. See Section 7.4.4, Programs, for details on how to create, edit and save programs.

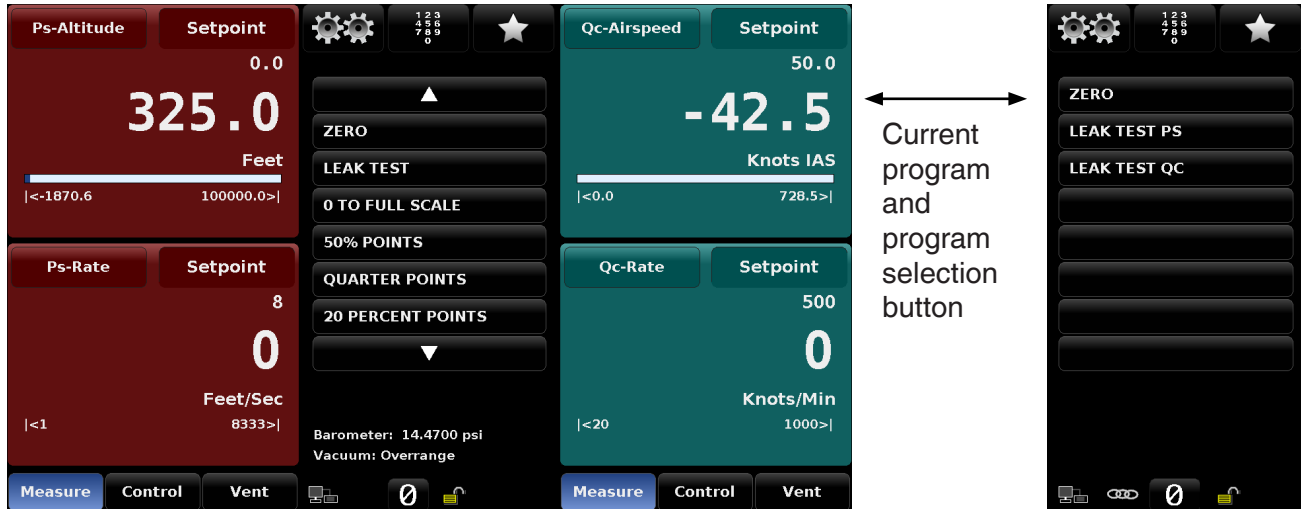









Figure 6.2.6.4 - Program Data Entry Screen

To select a program, press the current program's title to bring up a list of available programs. Pressing the up and down arrows will show more available programs. After a program has been chosen by pressing the program selection button, press the Play [  ] button to start the program. The Pause [  ] button can be pressed at any time to stop the program at the current step, then the Play [  ] can be pressed to resume. To move forward or backwards in the program press the Back [  ] button or the Forward [  ] button.

## 6.2.7 Favorites

The Favorites [  ] button provides a place to store programs that are frequently used and also contains several prepackaged programs that are used to perform a leak test and a single point zero of each transducer. Programs that are displayed in the Favorites menu are chosen in the Setup [  ] / Applications / Favorites screen. See [Section 7.4.5, Favorites](#), to select displayed favorites.

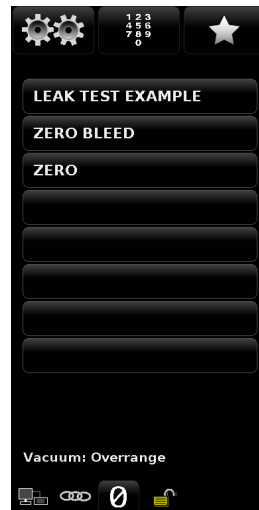

Figure 6.2.7 - Favorites

## 6.2.8 Status Bar

Located below the number pad is a status bar consisting of six icons.



Figure 6.2.8 - Status Bar



**Remote status:** The remote status indicator reports whether or not a remote terminal is connected. When a remote terminal is connected components of the icon will turn green. When a terminal is not connected those green components will grey out.



**Channel link status:** The Channel Link status indicator reports whether the two channels are linked or not. When linked placing one channel in Measure, Control or Vent mode will also change the other channel to that mode. When unlinked channels act independently.



**Zero reminder:** This Zero icon will turn orange if the customer programmed “Zero Reminder Interval” has been exceeded. When pressed the instrument will run an automated Zero sequence. See section 6.2.15 for more information.



**Screen lock:** This icon indicates the status of the touchscreen: locked or unlocked for manual interaction.





**Head height:** This icon indicates the current head height is non-zero, and the reading is adjusted based on the reference level settings. See Section 7.4.3.4 for more information on changing the reference level.



**Error indicator:** A yellow error indicator triangle indicates that there is an error recorded in the error register. Pressing the yellow error indicator will open the Setup [  ] / [Applications] / [Troubleshoot] screen where errors can be viewed. See [Section 7.4.6, Troubleshoot](#), for more information. The error register will clear itself when it is viewed, however, this does not correct the error. A corrective action still must be specifically addressed.

**6.2.9 Secondary Display**

There is an extra line available in the lower portion of each parameter screen reserved for the operator to (optionally) display the equivalent pressure or air data values in Metric, English or Avionics units (see figure 6.2.9a). The choices are available for selection in the Setup [  ] / [Ps, Pt or Qc] / [Secondary Display]. The Units displayed can be chosen in Setup [  ] / [Ps, Pt or Qc] / [Secondary Display Units]. The Ps secondary display units setup screen is shown in figure 6.2.9b below. An explanation on how to setup and choose options for this area is given in [Section 7.3.3, Secondary Display](#).



**Figure 6.2.9a - Secondary Display**

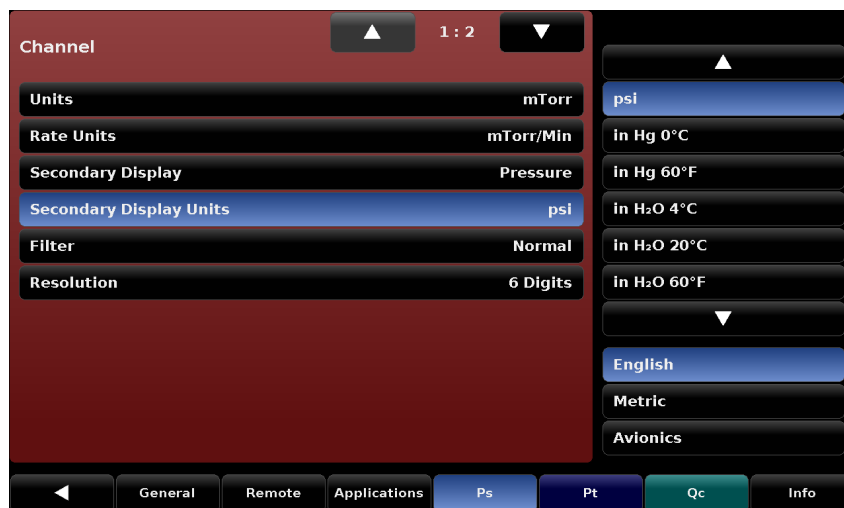

**Figure 6.2.9b - Setup Secondary Display Choices**

### 6.2.10 Limits





Limits are shown in four places in the main screen. Each parameter set ( Ps/Ps Rate, Qc/Qc Rate or Pt/Pt Rate) can have limits imposed by the operator. Limits and the relative pressure values within those limits are shown for Ps and Qc or Pt using a dynamic bar graph. Limits are shown numerically below the bar graph for the Ps and Qc or Pt parameters and at the bottom of the Ps Rate and Qc Rate or Pt Rate parameter windows. The limits are entered in the Setup [  ] / [Ps, Qc or Pt] [Maximum Limits]/ [Minimum Limits] screen (see Section 7.3.8). These limits restrict the value that can be entered as a setpoint for each parameter.



Figure 6.2.10 - Limits

**6.2.11 Instrument Modes / Avionics Units / Pressure Units**

There are three different instrument modes for the CPA8001 Air Data Test Set: “Ps/Qc Air Data”, “Ps/Pt Pressure”, and “Ps/Qc Pressure”. The Mode is selected in Setup [  ] / [General] / [Instrument Mode]. Ps/Qc Air Data Mode uses Feet or Meters for altitude, and Knots, MPH, km/hr, m/s or Mach for airspeed. Both Ps/Pt Pressure and Ps/Qc Pressure modes use a variety of English or Metric pressure units plus two user defined units. The denominator for the rate unit for each channel can be Seconds [Sec] or Minutes [Min]. The Rate Unit is selected in Setup [  ] / [Ps, Pt, or Qc] / [Rate Units]. The numerator of the rate unit will always be identical to the associated unit selected for that parameter’s channel.

The unit chosen is displayed directly under the current reading for each parameter on the main screen, just above the bar graph and the numerical limits. The Setup screen for each parameter can be accessed directly by touching the associated channel setup key for example [  ]. This will open the channel setup screen where the unit can be changed.



**Figure 6.2.11 - Pressure Units**

There are several tables of conversion factors for pressure units and pressure / altitude in [Section 11, Appendix](#). The PSI table includes the factors for conversion to or from PSI to all of the other available units. Another table uses Bar as the basis for conversion factors to or from most of the more common alternative units.

**6.2.12 Pressure Type**

Ps is an Absolute pressure (reference is absolute zero), Qc is a differential pressure and can be referenced to atmospheric pressure or to the current Ps pressure. Pt is an absolute pressure (reference is absolute zero).



Notice

**Appendix 11.1** gives an overview of altitude and airspeed avionics terminology and hardware and includes definitions of Ps, Pt and Qc.



### 6.2.13 Operating Modes

Each channel of the CPA8001 has three operating modes: Measure, Control, and Vent. When the system is turned on and the channels are initialized, both channels will automatically be placed in Vent Mode. The operator can switch from one mode to another by using the mode selection keys located just below each channel on the front panel display. If channels are linked (see Section 7.1.2 Linked Modes) a mode change in one channel will also change the mode in the other channel. When unlinked channel modes must be changed independently.



Notice

When switching from Control mode to Measure mode, the system will not be vented and the last applied pressure will be locked in the system by means of a solenoid valve.

When the instrument is turned off all solenoids revert to their un-powered state: normally open (NO) or normally closed (NC) as shown on schematics in this section. (See Figure 6.2.13.4)

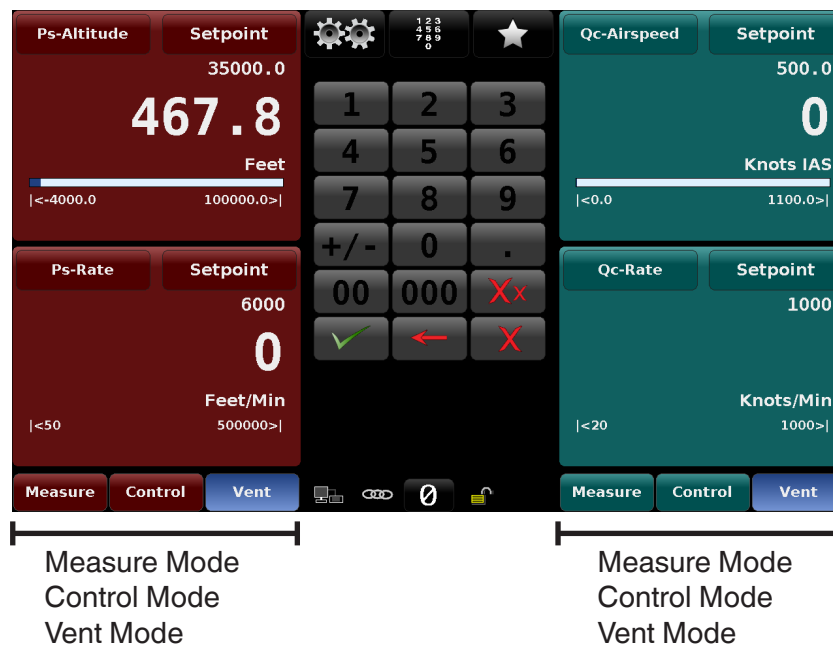

Figure 6.2.13 - Operating Modes

Measure Mode:	Control Mode:	Vent Mode:
<p>In Measure mode the CPA8001 measures the pressure applied at the Measure/Control port.</p> <p>If the Control mode was the last used mode before switching into Measure mode, the last controlled pressure is held in the test assembly.</p> <p><a href="#">See Section 6.2.13.1, Measure Mode</a></p>	<p>In Control mode the CPA8001 provides a controlled pressure at the Measure/Control port equal to the setpoint value.</p> <p><a href="#">See Section 6.2.13.2, Control Mode</a></p>	<p>The Vent function will vent the system to the atmosphere, including the test assembly connected to the Measure/Control port.</p> <p><a href="#">See Section 6.2.13.3, Vent Mode</a></p>

### 6.2.13.1 Measure Mode

In Measure mode, the instrument measures the pressure at the transducer connected to the Measure/Control port. The Measure mode is activated by pressing the [Measure] button.

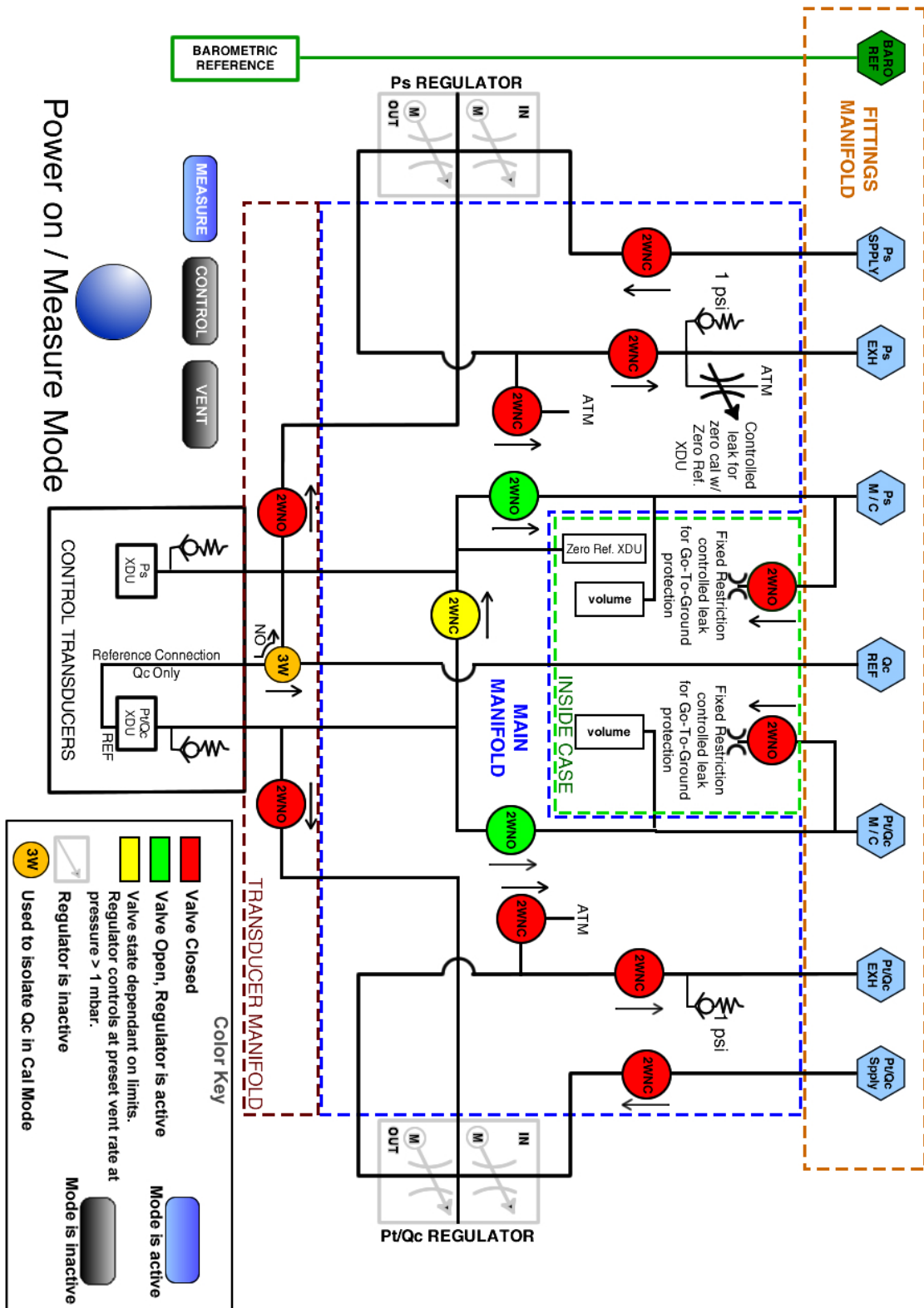

Figure 6.2.13.1a - Measure Mode

If the pressure is beyond the permissible measurement range, the pressure reading is displayed in red instead of white figures. As soon as a pressure of approximately 110% of the full scale nominal range is reached, an integrated safety relief valve opens and releases the pressure into the inside of the instrument. The regulator is not active in Measure mode.

The setpoint values can be input while in the Measure mode then Control mode can be activated by pressing the [Control] key and the CPA8001 will start to control to the setpoint values.

The figure below shows the state of the isolation valves in Measure mode.



6.2.13.1b - Isolation Valves in Measure Mode

### 6.2.13.2 Control Mode

In Control mode, the instrument provides a precise pressure, altitude or airspeed output at the Measure / Control Port. The indication of the current value will turn green when the setpoint has been reached and the stable window settings have been satisfied.



Figure 6.2.13.2a - Control Mode

The Control mode is activated by pressing the [Control] button in the main menu for either channel. If channels are linked, pressing [Control] on one channel will activate control in the other. When unlinked the channels act independently. The Control mode can be chosen while in the Measure mode or the Vent Mode by pressing the [Control] button. In the Control mode the CPA8001 provides a stable pressure, altitude or airspeed output at the Measure/Control port.

In order to ensure the controller is correctly configured for the task it is to perform, the following steps must be taken and the respective parameters set in each channel's Setup [  ] menu.

- In order to control pressures close to or below atmospheric pressure or altitudes close to or above sea level, a vacuum pump should be connected to each channel's Exhaust port.
- The Control rate can be set in the rate parameter area in the lower portion of each channel screen.
- Control limits can be set in the Setup [  ] / [Ps, Pt, or Qc] / [...limits] screen.



### 6.2.13.3 Vent Mode

Vent mode acts as a safe “Go-To-Ground” function. Pressing the Vent button will activate a controlled vent to relieve the pressure in the system and in the device connected to the measure control port. The pressure will be controlled through the regulator toward atmospheric pressure (zero altitude) at an operator defined vent rate and then, at 1 mbar from atmospheric pressure, will vent through a solenoid valve and a 0.0079 inch diameter orifice. The Default values for the vent rate is 5000 ft/min. The operator can change the vent rate by selecting [  ] / [Ps, Pt, or Qc] / [Vent Rate]. These precautions are taken to protect the device being tested which may be susceptible to damage from rapid changes in pressure. On loss of power the instrument will vent through the orifice. The Vent mode can be activated from the Measure or Control mode by pressing the [Vent] button. Internal system pressure will be vented through the Exhaust port.

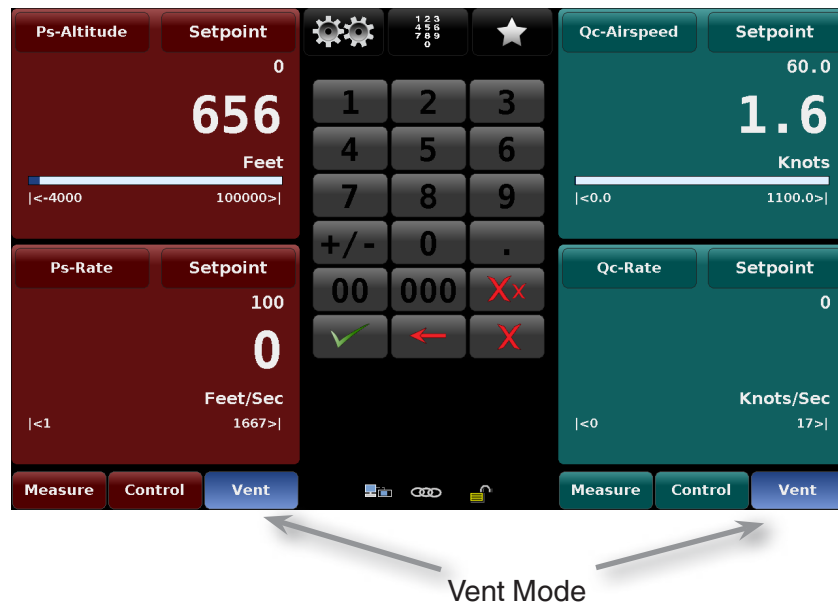

Figure 6.2.13.3a - Vent Mode



**In cases where the default Vent Rate and Vent Limit are not adequate to protect a device connected to the measure / control port, a user define value should be entered for the Vent Rate and the Vent Limit**

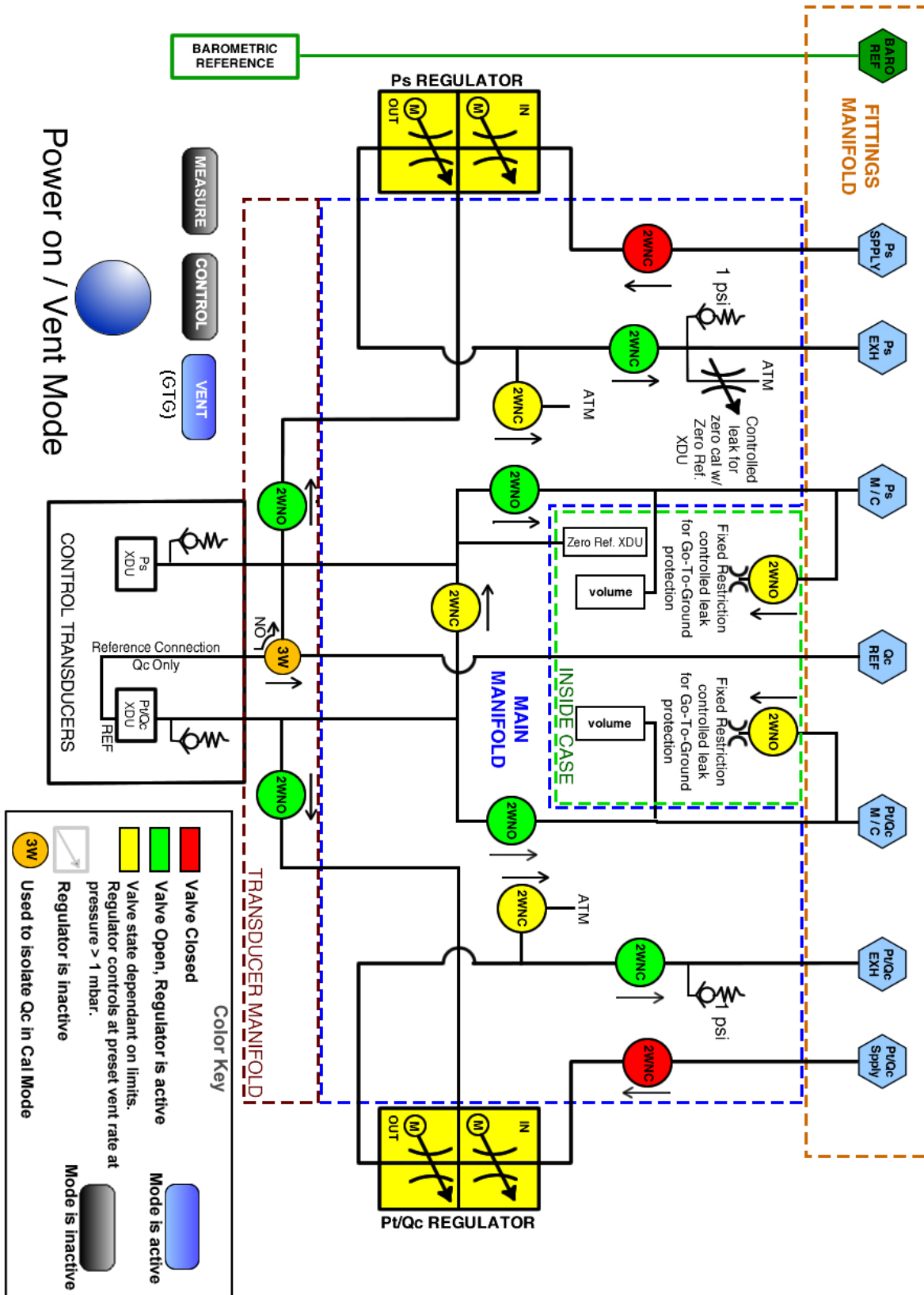
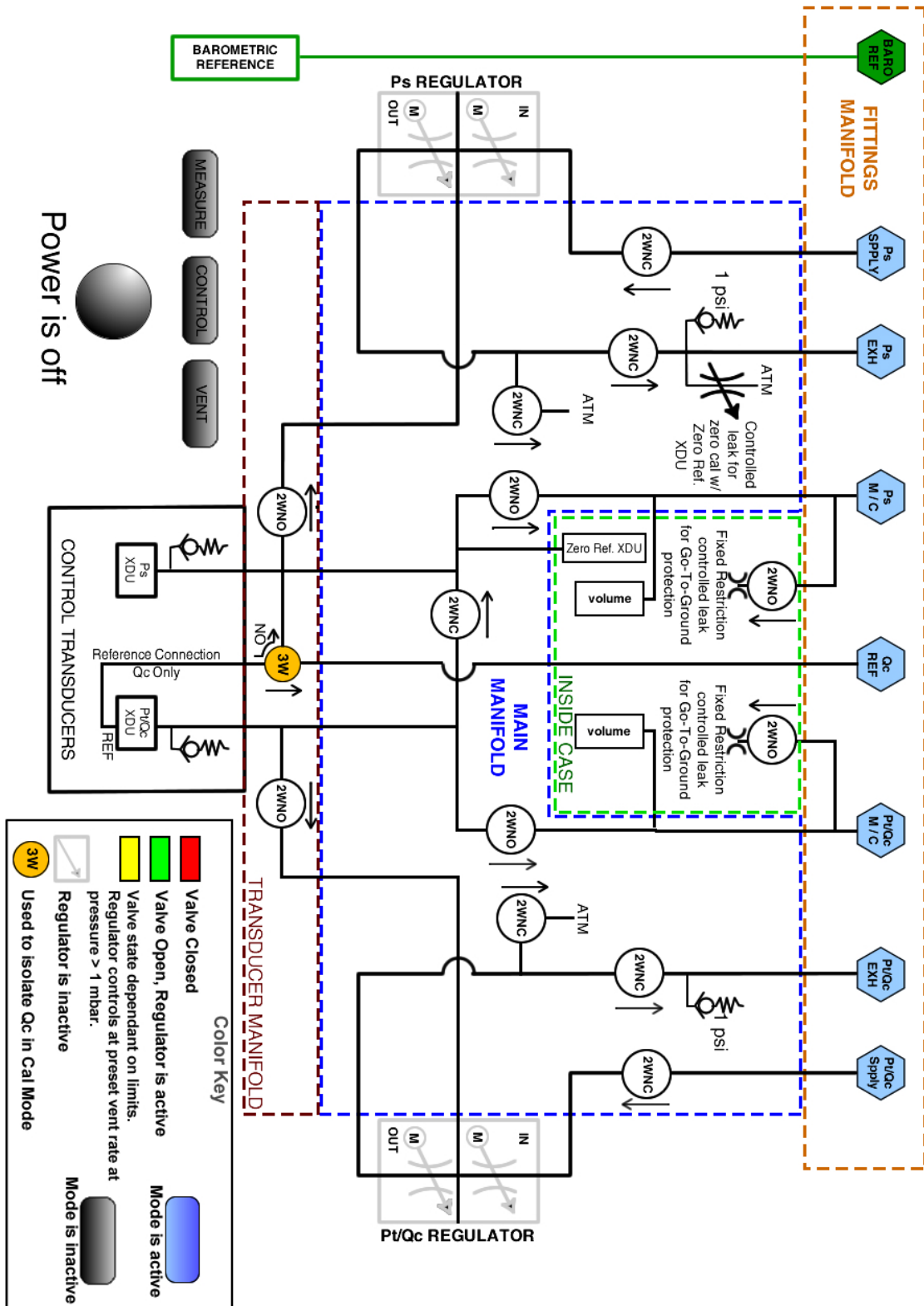

Figure 6.2.13.3b - Illustration Showing Isolation Valves in Vent Mode

**6.2.13.4 State of the Isolation Valves when the CPA8001 is off**

When the CPA8001 is turned off the valves revert to their normal state: either Normally Open (NO) or Normally Closed (NC) and the regulator becomes inactive, as indicated below.



**Figure 6.2.13.4 - Power Off**



### 6.2.14 Vacuum Setting

The CPA8001 requires a stable vacuum for accurate measurements and for zeroing the Ps and Pt transducers. This is achieved by running a pre-programmed zero bleed sequence. The zero bleed sequence can be accessed by pressing the Data Entry [  ] button in the main screen. Then, select “Programs” and current programs’ title to bring up the available programs. Scroll down to select “Zero Bleed.”



**Ensure that a vacuum pump is connected to the Ps exhaust port before beginning the zero bleed sequence.**

Once the “Zero Bleed” program is selected, press the Play [  ] button to start the program. This will isolate the vacuum inside the CPA8001 and stabilize the vacuum reading sensed by the vacuum transducer. The vacuum reading is considered stable when the reading turns green (Figure 6.2.14b).

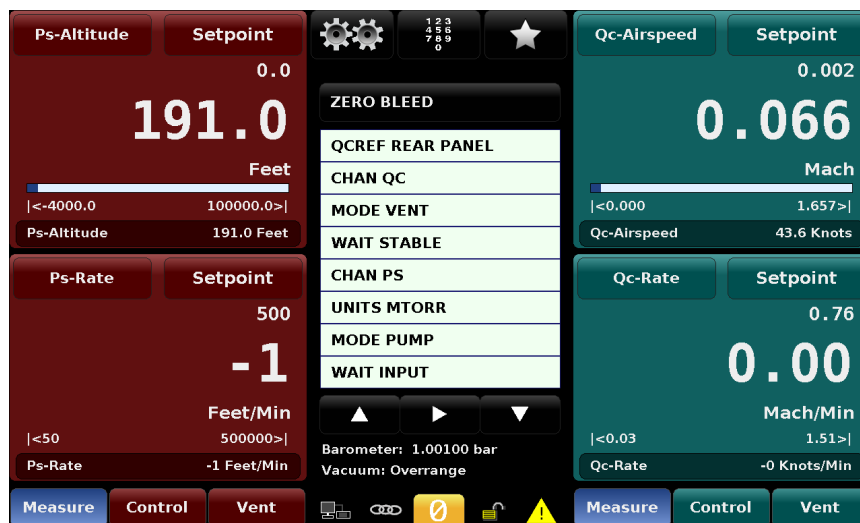

Figure 6.2.14a - Zero Bleed Sequence



Figure 6.2.14b - Vacuum Stable Indication

Note the stable vacuum reading, this reading needs to be within 400 - 700 mtorr for accurate zero calibration of the Ps and Pt transducers. When the vacuum reading is outside the 400 - 700 mtorr tolerance, the vacuum level inside the CPA8001 is adjusted by the vacuum bleed valve on the rear panel of the instrument (Figure 6.2.14c). The valve should be turned clockwise, if the stable vacuum reading is above 700 mtorr and anti-clockwise if the reading is below 400 mtorr.



Figure 6.2.14c - Rear Panel with Vacuum Bleed Valve



**The vacuum bleed valve is highly sensitive to minor adjustments. It should be adjusted using a flat head screwdriver. The adjustments should be made incrementally with a maximum of 5 degree rotation of the valve while monitoring the stable vacuum reading between each increments.**

## 6.2.15 Automated Zero

The Auto Zero function automatically zeros the Qc transducer at atmospheric pressure and the Ps and Pt transducers using a high accuracy internal vacuum reference transducer.

The Zeroing function is initiated by pressing the Zero button [  ] shown in the screen below.



Figure 6.2.15a - Main Screen with Zero Option

A second screen (below) will appear where the zeroing sequence can be initiated by pressing the check button [  ].



Figure 6.2.15b - Initiate/Cancel Zero Process

Pressing the check button will start a sequence that will progress as follows:

1. If a Ps/Qc transducer is installed, the sequence will start by zeroing the Qc transducer at atmospheric pressure then it will zero the Ps transducer as described in steps 2-5. If there is a Ps/Pt transducer installed, the process will start at step 2.
2. The sequence will open the system to the external vacuum pump and allow the system to be pumped down, this may take about 5 minutes.
3. When the system pressure is less than 600 mtorr there will be a delay period of 180 seconds (See figure 6.2.15c below) to allow the system pressure to equalize. During this 180 seconds period of time, the pressure must stay within 400 ... 700 mTorr with a change less than 1 mTorr.
4. If a Ps/Qc transducer is installed, the sequence will perform single point zero calibration of the Ps transducer. Otherwise, with a Ps/Pt transducer installed, a single point zero calibration of the Ps and Pt transducers will be performed.
5. Finally all channels will be vented. Upon completion a summary of the zero process will be displayed.



Figure 6.2.15c - Zero Sequence, 120 second delay

## 7. Setup

After the instrument has been powered on and the main screen is displayed, press the Setup [  ] button to setup parameters or make changes to the instrument settings.

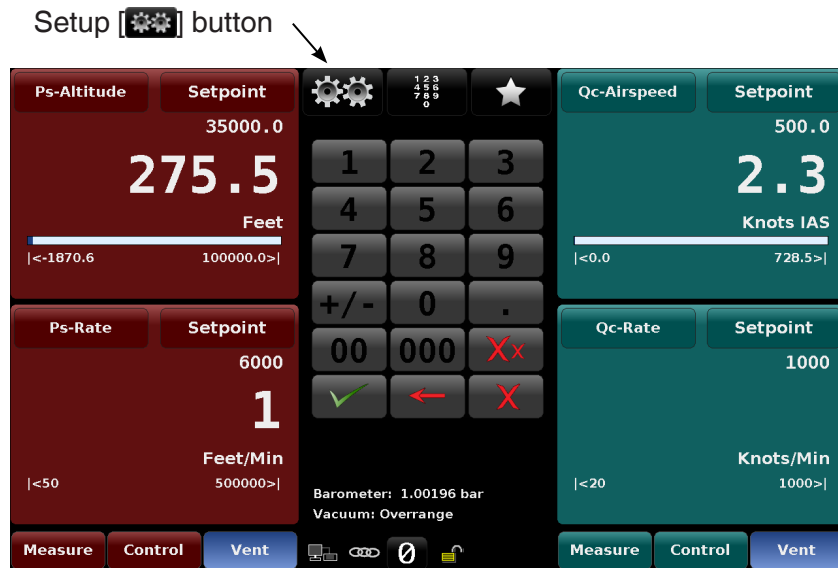

**Figure 7a - Location of the Setup [  ] button on the main screen**

The following is a menu tree that shows the general layout of the setup menus. The bullet points in blue represent screens that require the calibration password to view.

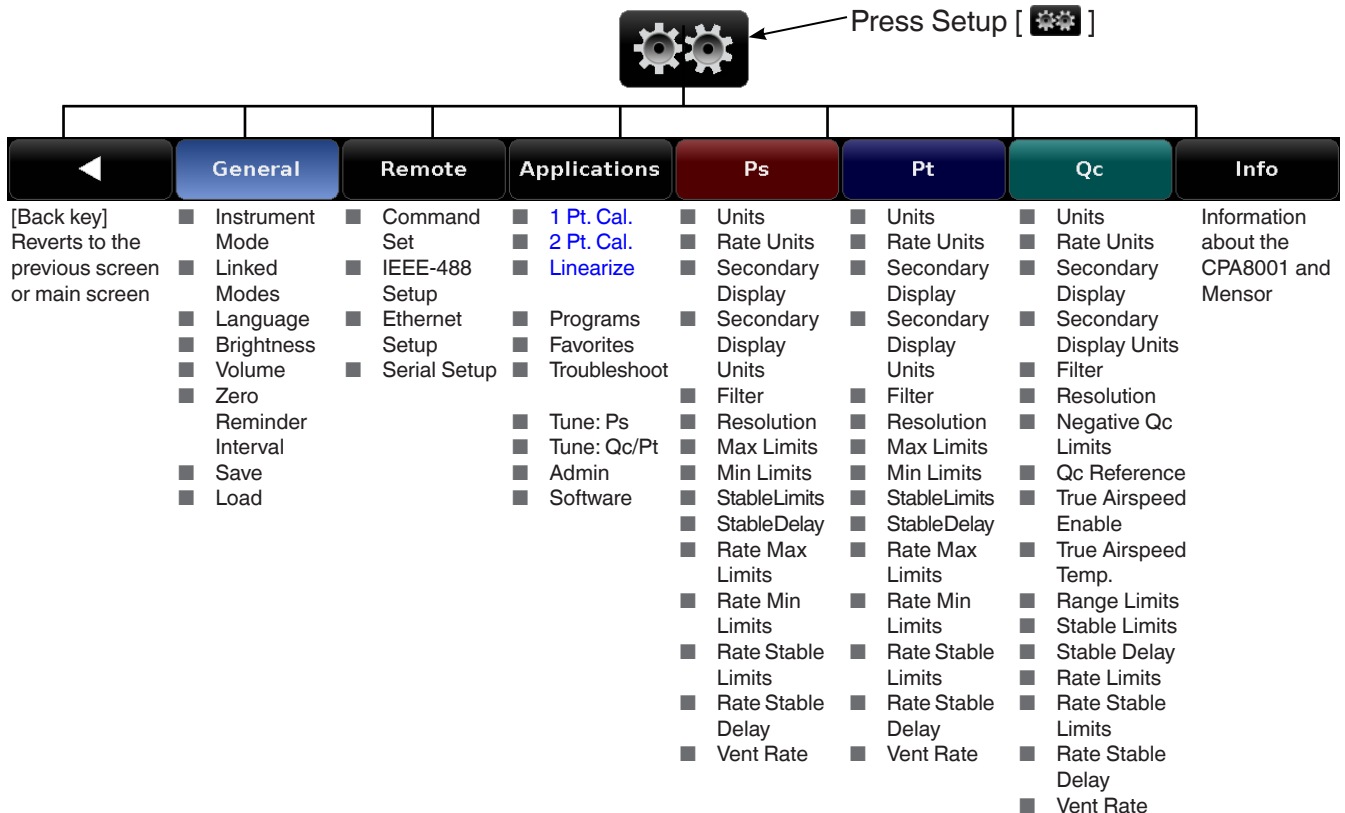

**Figure 7b - Menu Tree of the Setup Menus**

## 7.1 General Tab

### 7.1.1 Instrument Mode

The Instrument Mode is accessed by pressing Setup [  ] / [General] / [Instrument Mode]. The instrument mode has three settings: [Ps/Qc Air Data], [Ps/Pt Pressure] and [Ps/Qc Pressure]. These modes are slightly different depending on what type of transducer module is physically installed in the instrument.

For a CPA8001 with a Ps/Qc transducer module installed, the Ps/Qc Air Data mode and the Ps/Qc Pressure mode will use the output readings directly from the Ps and Qc transducers for all functions. In this configuration the Pt reading in the Ps/Pt Pressure mode will be a calculated (emulated) value derived from the equation  $P_t = P_s + Q_c$ .

On the other hand, if a Ps/Pt transducer module is installed, the Ps/Pt Pressure mode will use the output readings directly from the Ps and Pt transducers for all functions. In this configuration the Qc readings in the Ps/Qc Air Data mode and the Ps/Qc Pressure mode will be a calculated (emulated) value derived from the same equation  $P_t = P_s + Q_c$ , or algebraically reordered  $Q_c = P_t - P_s$ .

Refer to Appendix section 11.1 for Air Data variable definitions.

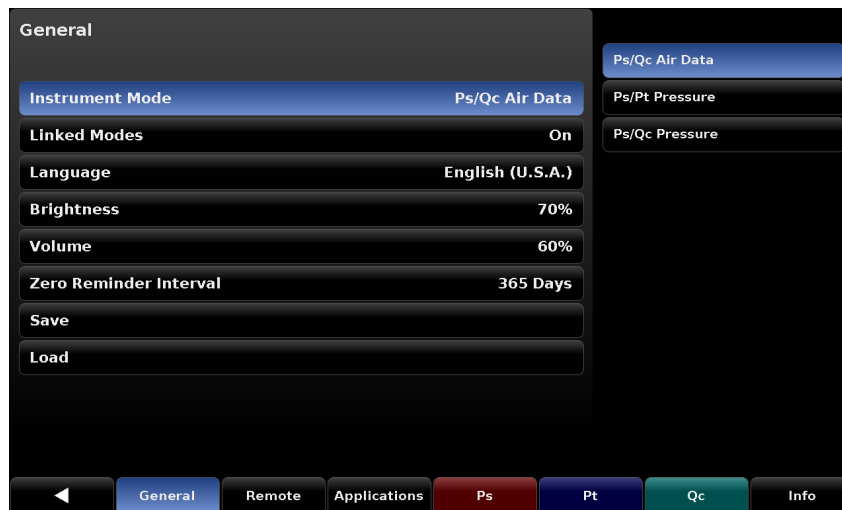



Figure 7.1.1 - Instrument Mode with Ps/Qc Air Data chosen

### 7.1.2 Linked Modes

The Linked Mode is accessed by pressing Setup [  ] / [General] / [Linked Modes]. Linked Modes has two settings: [on] and [off]. The [on] selection turns on a functional link between channels with respect to the Control Modes: Measure, Control and Vent. When the [on] is selected the linked icon [  ] will appear in the main screen and selection of the Measure, Control or Vent Control mode in one channel will change the other channel to the same mode. If [off] is selected the Control Mode of each channel is independent of the other; selecting a Control Mode in one channel will not effect the mode of the other channel.

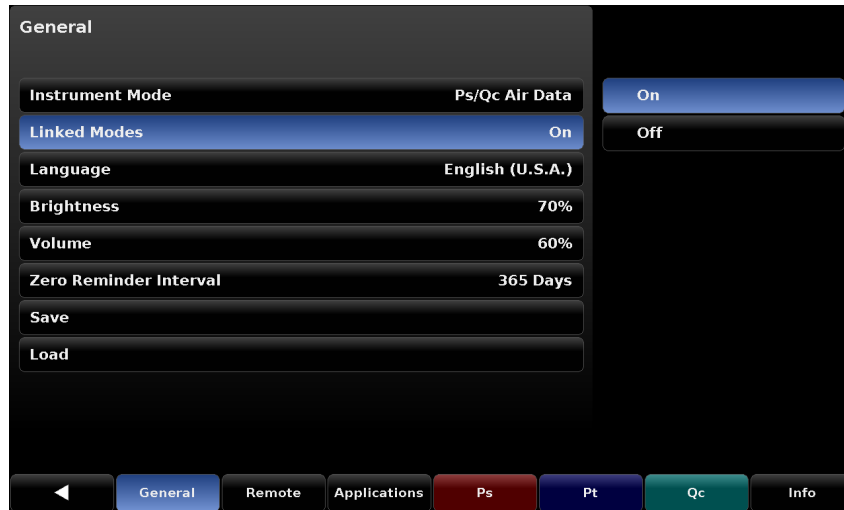

Figure 7.1.2 - Linked Modes

### 7.1.3 Language



The languages that are available in the CPA8001 are shown by pressing Setup [  ] / [General] / [Language]. The current available languages are shown on the right side of the screen with the selected language highlighted in blue. Pressing the desired language will make that language active on every screen in the CPA8001.



Figure 7.1.3 - Language

### 7.1.4 Brightness

The selection for screen brightness is accessed by pressing Setup [  ] / [General] / [Brightness]. This menu provides a place to set the global brightness of the instrument’s screens. When the [Brightness] button is chosen a graduated brightness “bar graph” will appear on the side. This is a sliding scale of brightness and can be changed by sliding ones finger up and down on the bar graph or simply touching an area on the graph that corresponds to a brightness level.

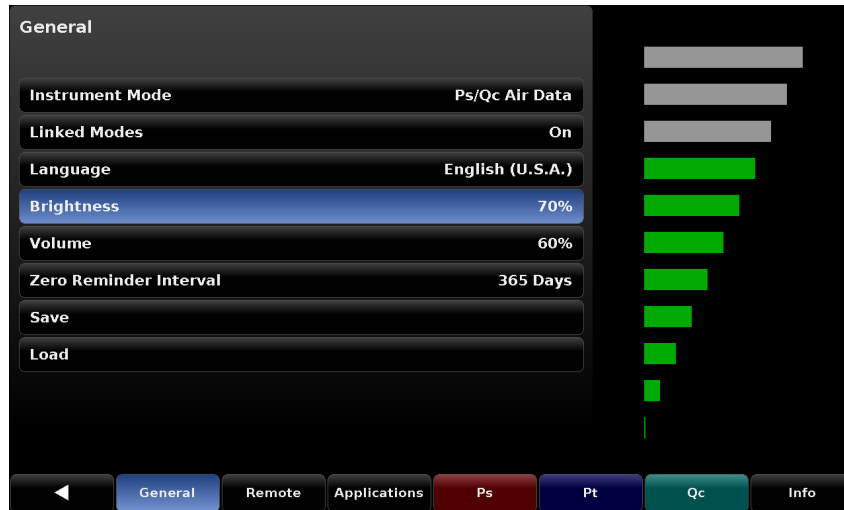



Figure 7.1.4 - Brightness

### 7.1.5 Volume

The selection for Volume is accessed by pressing Setup [  ] / [General] / [Volume]. This menu provides a place to set the global volume for the instrument’s auditory feedback sounds. When the [Volume] button is chosen a graduated volume “bar graph” will appear on the side. This shows the relative volumes available and can be changed by sliding ones finger up and down on the bar graph or simply touching an area on the graph that corresponds to the desired volume level.

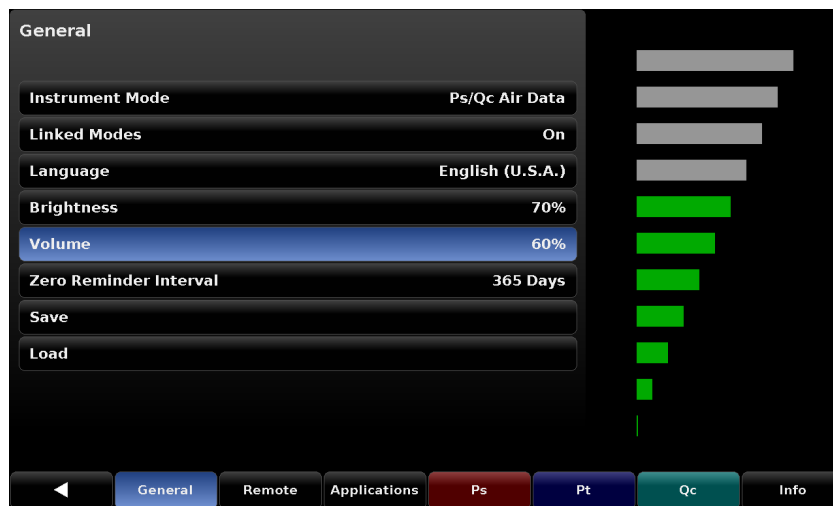



Figure 7.1.5 - Volume

### 7.1.6 Zero Reminder Interval

By pressing Setup [  ] / [General] / [Zero Reminder Interval], an interval can be set that serves as a reminder that it is time to perform the automated zero on the internal Ps and Pt or Qc transducers. After the interval elapses, the zero indicator and actuation key [  ] on the main screen turns orange as a reminder to perform the automated zero function. The interval can be set to a number of days from 1 to 365. Each individual transducer's zero drift characteristic will vary slightly and the interval can be set to correct for these variances. Note: A vacuum sensor must be installed for this feature to be enabled. See section 6.2.15, Automated Zero.

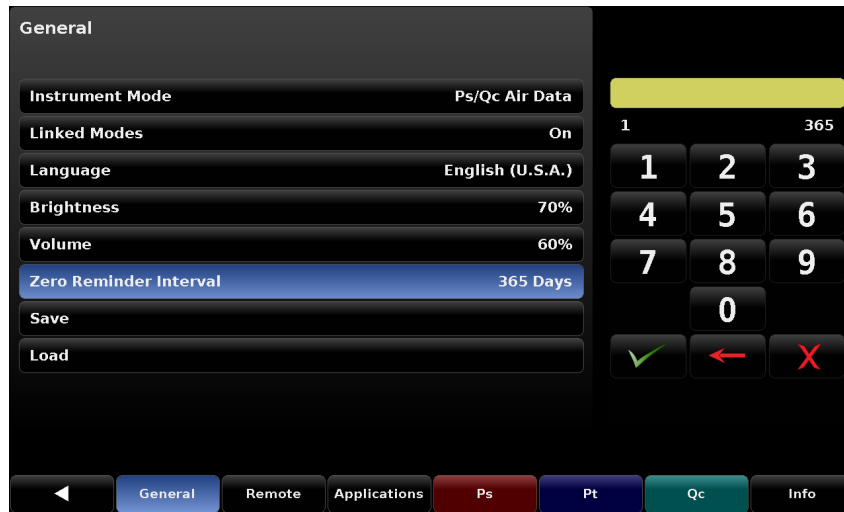





Figure 7.1.6 - Zero Reminder Interval

### 7.1.7 Save [Configuration]

The screen used to save a configuration for the instrument is accessed by pressing Setup [  ] / [General] / [Save]. Configurations might contain a setting for a specific unit of measure or an optional display item or even a setpoint or limits. Anything that can be set or changed in the CPA8001 can be loaded in a configuration and recalled later. Simply set the instrument with the desired configurable settings, then go to the Setup [  ] / [General] / [Save] menu and touch a configuration number then touch the Check Mark [  ]. This sets the current configuration in that numbered selection. This is useful to save time when performing a specific test that requires a specific configuration. Reloading a saved configuration is covered in 7.1.8, Load [Configuration].

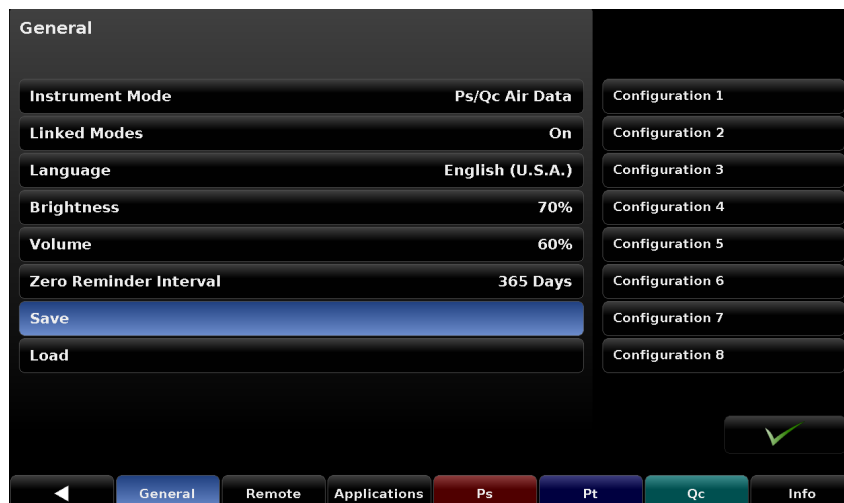



Figure 7.1.7 - Save [Configuration]



### 7.1.8 Load [Configuration]

To load a preset configuration, access Setup [  ] / [General] / [Load]. The CPA8001 can store a complete set of parameters and settings, see section 7.1.7 Save [Configuration] above. Each Configuration can be recalled (loaded) as needed. The [Load] button within the [General] tab of the Setup [  ] menu, shown in Figure 7.1.8, provides a place to choose the predefined configurations for the instrument. When the [Load] button is chosen a choice of several configurations are displayed on the sidebar. When one configuration is chosen its settings will be applied to the instrument.

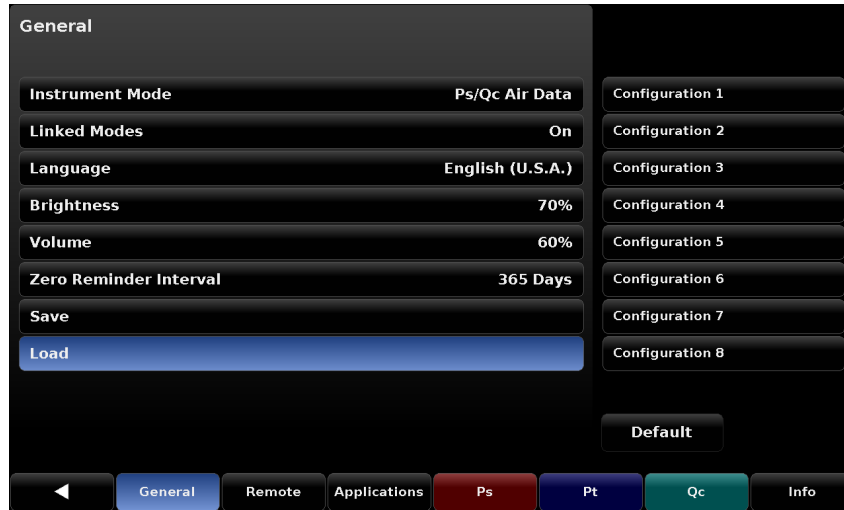





Figure 7.1.8 - Load [Configuration]

## 7.2 Remote Tab

Within the [Remote] tab of the Setup [  ] menu are parameters used to configure the communications to and from the CPA8001. The command set being used, and the settings for IEEE-488, Ethernet, and Serial communications are in these menus. This menu has two pages that can be accessed by pressing the up or down [  1 : 2  ] page button.

### 7.2.1 Remote Command Set

The Command Set selection can be accessed in the Setup [  ] / [Remote] / [Command Set] menu. This menu provides a place for the operator to choose which command set will be used within remote communication software used to remotely control the function of the CPA8001. When the [Command Set] button is chosen any of the listed command sets seen in the side bar can be selected. This will immediately change the active command set enabling the instrument to respond to commands in that set. See [Section 8, Remote Operation](#), for a list of commands included in each command set.

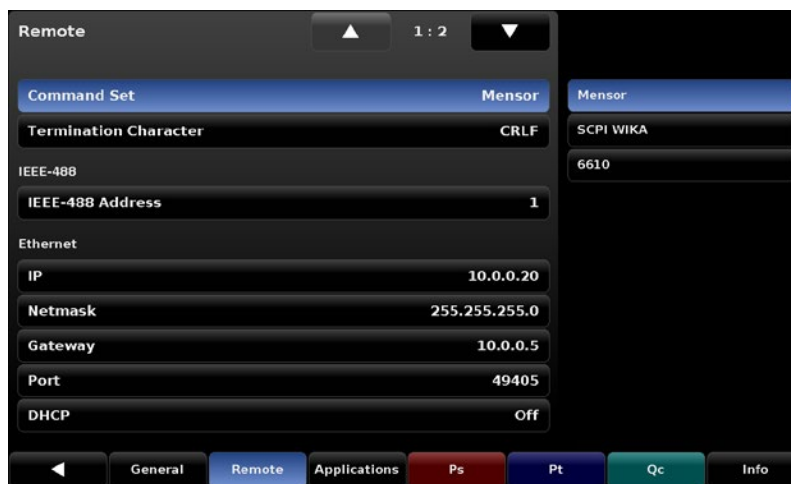



Figure 7.2.1 - Remote Command Set

### 7.2.2 IEEE-488 Address

The IEEE-488 address can be set in the Setup [  ] / [Remote] / [IEEE-488 Address] menu. When the [IEEE-488 Address] button is pressed a numeric key pad appears where an address from 1 to 31 can be entered.

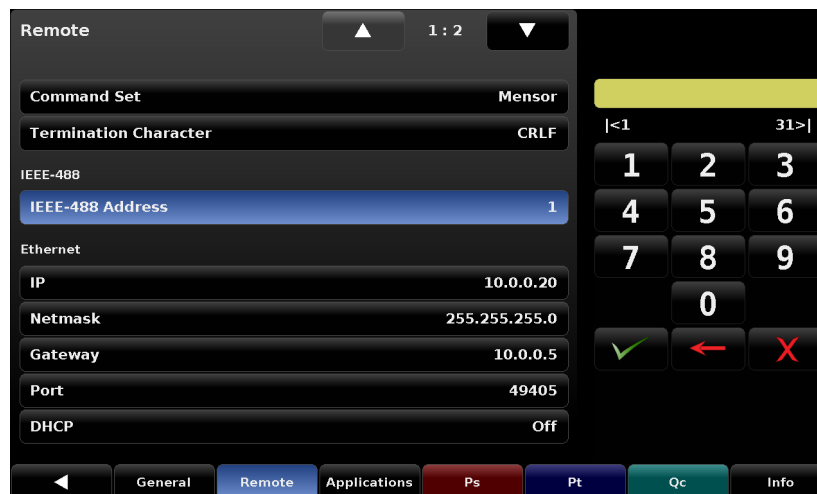



Figure 7.2.2 - IEEE-488 Address

### 7.2.3 Ethernet Communication

The Ethernet Communication parameters are accessed in the Setup [  ] / [Remote] menu. The IP Address, Netmask, Gateway, Port and DHCP settings can be entered here. When each parameter button is pressed a numeric key pad or a choice selector will be presented on the right side and an appropriate number or selection can be entered for the respective parameter. These parameters should be set up to match your host computer.

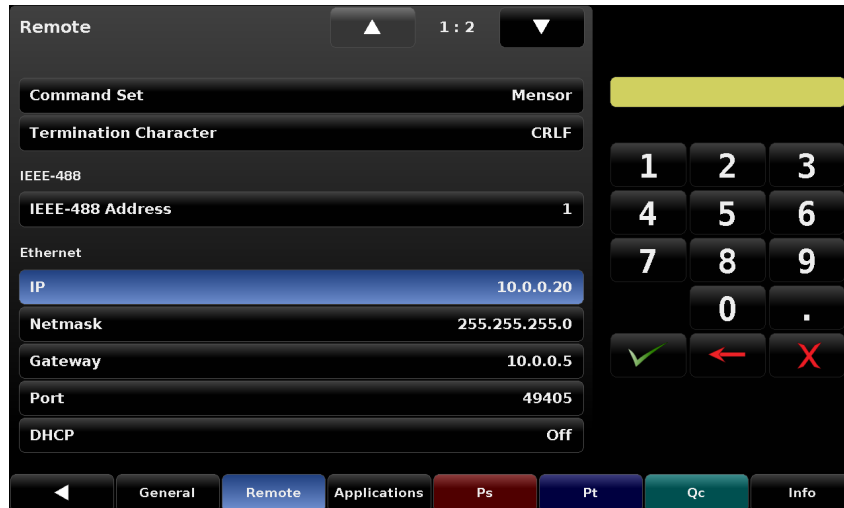

Figure 7.2.3 - Ethernet Communications

### 7.2.4 Termination Character

The termination character of the remote response (transmit termination) may be changed to one of the following:

CRLF	Carriage return and line feed
CR	Carriage return
LF	Line feed
EOI	End of input
None	No termination
Default	Set to the default termination character for the active command set.

Defaults:	CRLF
	SCPI WIKA = LF
	6610 = CRLF

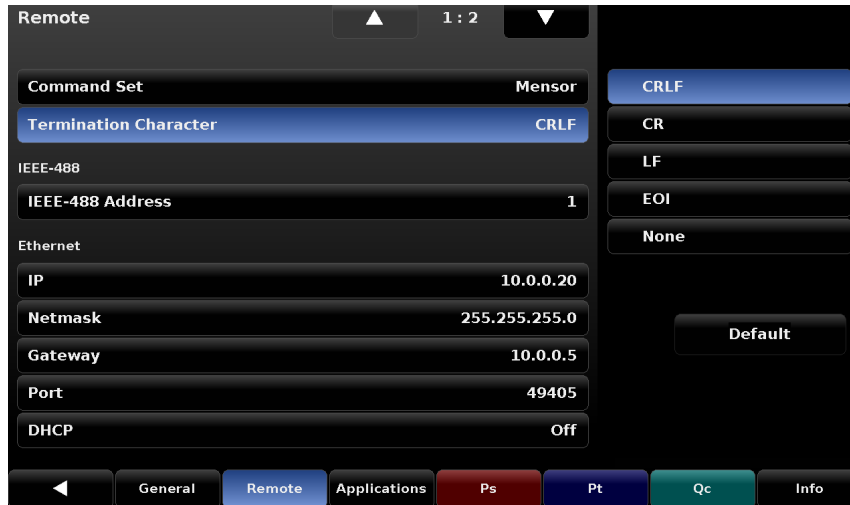



Figure 7.2.4 Termination Character

### 7.2.5 Serial Communications

Serial Communication parameters are set on the second page of the Setup [  ] / [Remote] Menu. Settings for the Serial parameters: Baud Rate, Data Bits, Stop Bits, Parity and Echo are available here. When a parameter button is pressed a choice selector will be presented on the right side and an appropriate selection can be entered for the respective parameter. These parameters should be set up to match your host computer.

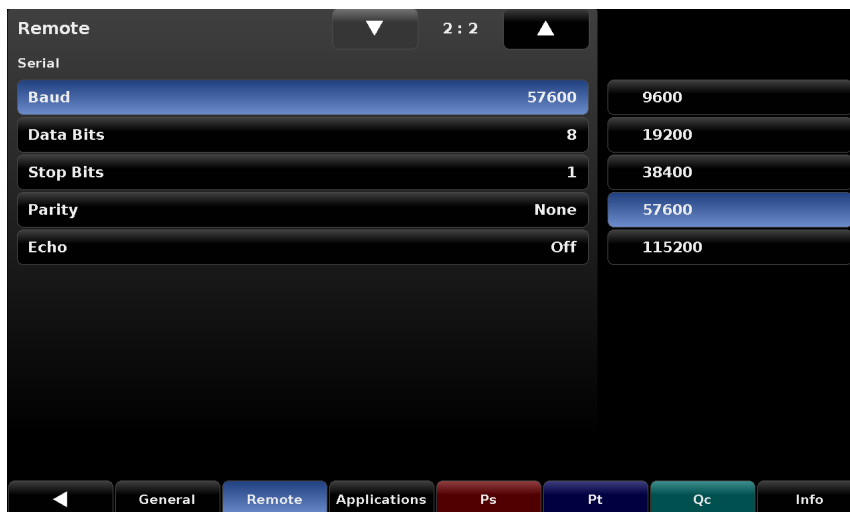





Figure 7.2.5 - Serial Communications

### 7.3 Channel Setup [Ps], [Pt] and [Qc]

Channel setup screens for Ps, Pt and Qc are identical except for four additional parameter in the Qc Channel which are “Negative Qc Limit”, “Qc Reference”, “True Airspeed Enable” and “True Airspeed Temperature” (explained in [Section 7.3.7](#)) and the Pt channel cannot be configured with Air Data units, only pressure units. Channel Setup Screens are accessed through the Setup [  ] / [Ps], [Pt] or [Qc] menus. There are two pages in each of the menus, one labeled “Channel” and the other labeled “Limit”. Figure 7.3a shows the “Channel” page and Figure 7.3b shows the ”Limit” page for the Ps channel. Pages are accessed by pressing the Page Up [  ] or Page Down [  ] button.

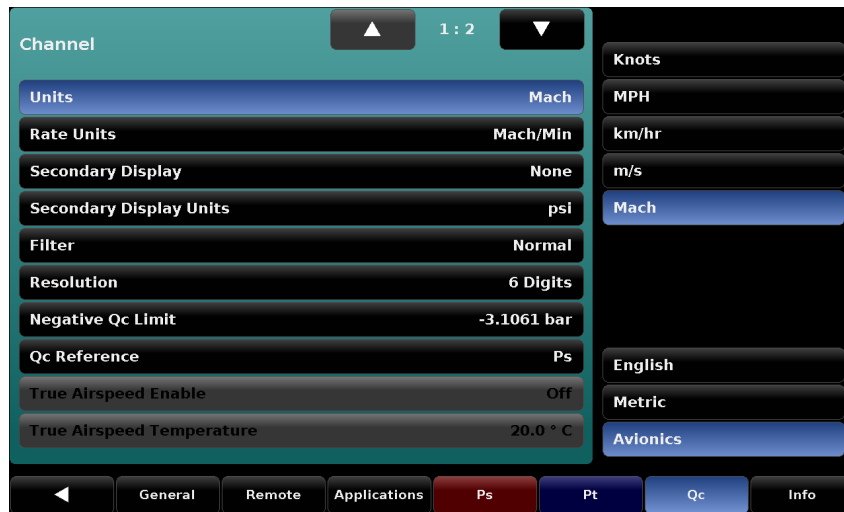

Figure 7.3a - Channel Page of Ps Setup

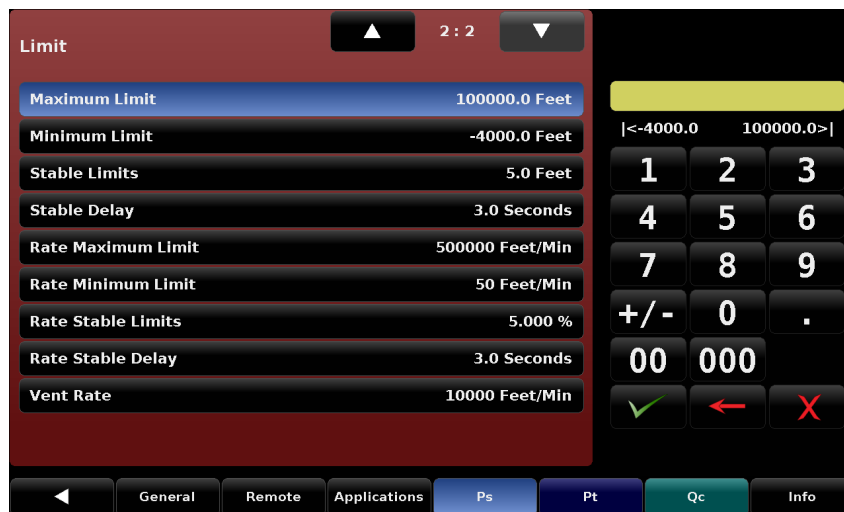

Figure 7.3b - Limit Page of Ps Setup

### 7.3.1 Setup Units

The pressure or avionics unit is set within the Setup [⚙️] / [Ps], [Pt] or [Qc] menu using the [Units] button. There are three choices for Ps and Qc and two choices for Pt on the right side of this menu: [English], [Metric] for the Pt channel and [English], [Metric] or [Avionics] units for the [Ps] and [Qc] channel. The units chosen are displayed as the primary unit for each channel and in the numerator of the associated rate.



Figure 7.3.1 - Ps units menu showing English units

### 7.3.2 Rate Units

The time denominator (1/sec or 1/min) of the rate unit for each channel (Ps, Pt, or Qc) is set within the Setup [⚙️] / [Ps], [Pt] or [Qc] menu using the [Rate Units] button. It can be set for seconds [Sec] or minutes [Min]. The numerator for the rate will always be the same as the unit chosen with the Setup [⚙️] / [Ps], [Pt] or [Qc] / [Units] Button.



Figure 7.3.2 - Ps Rate Units (showing Feet/Min)

### 7.3.3 Secondary Display

The Secondary Display is used to set an additional, alternative display showing a unit that is different from the primary display unit. The Secondary Display is set using the Setup [⚙️] / [Ps], [Pt] or [Qc] / [Secondary Display] button. Choices are [None], [Pressure] or [Altitude]/[Airspeed] for Ps & Qc respectively. For Pt, the choices are [None] or [Pressure]. Choosing [None] turns off the secondary display. See Section 6.2.9 for main screen location of the secondary display.

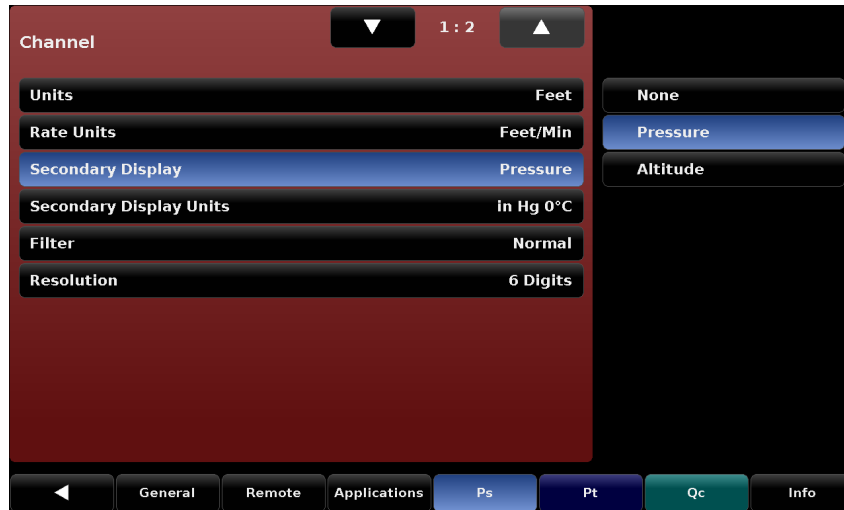

Figure 7.3.3 - Ps Secondary Display set to [Pressure]

### 7.3.4 Secondary Display Units

As with the main display Units, the Secondary Display Units have the same choices accessed through the Setup [⚙️] / [Ps], [Pt] or [Qc] menu using the [Secondary Display Units] Button. There are three choices for Ps and Qc and two choices for Pt (shown below) on the right side of this menu: [English] or [Metric] units for the Pt channel and [English], [Metric] or [Avionics] units for the Ps and Qc channel. The units chosen are displayed as the unit for each secondary display in the channel and in the numerator of the associated rate.

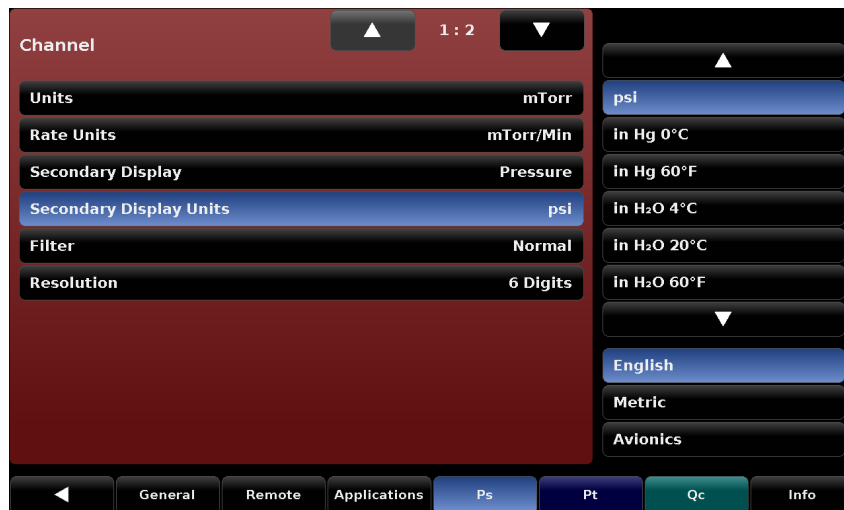



Figure 7.3.4 - Secondary Display Units, [Ps] ... [psi]

### 7.3.5 Filter

Selections to change the transducer reading display filter is found in the Setup [  ] / [Ps], [Pt] or [Qc] [Filter] menu. The filter can be set to Off, Low, Normal or High. The transducer filter acts on the output pressure indicated on the instrument, filtering out small pneumatic and electrical variations in the pressure transducer output. This is done by mathematically smoothing the output reading using a low pass filter on the output of the pressure transducer. Figure 7.3.5 shows the Qc filter set to “Normal”.

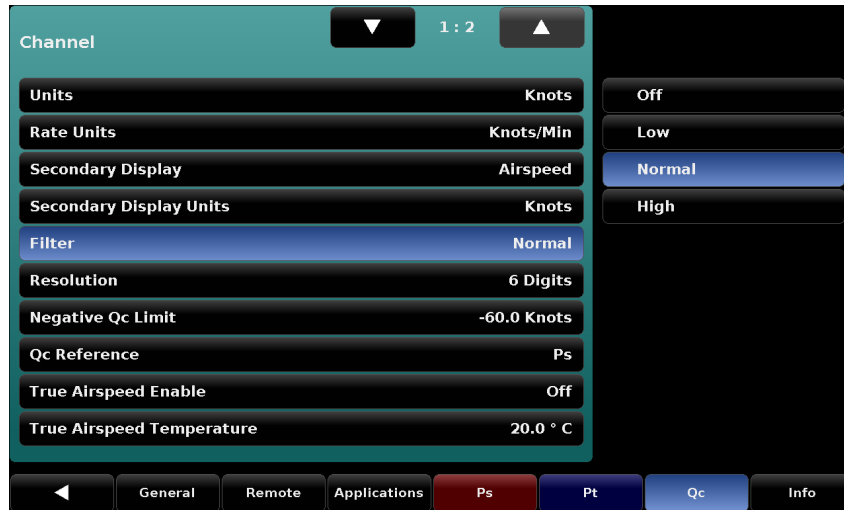



Figure 7.3.5 - Filter, [Qc] / [Filter] / [Normal]

### 7.3.6 Resolution

The Resolution setting is accessed in the Setup [  ] / [Ps], [Pt] or [Qc] / [Resolution] menu. The current resolution setting is shown with a blue background. Selecting [4], [5] or [6] from the right side selection menu will set the display reading resolution to 4 digits, 5 digits or 6 digits respectively.

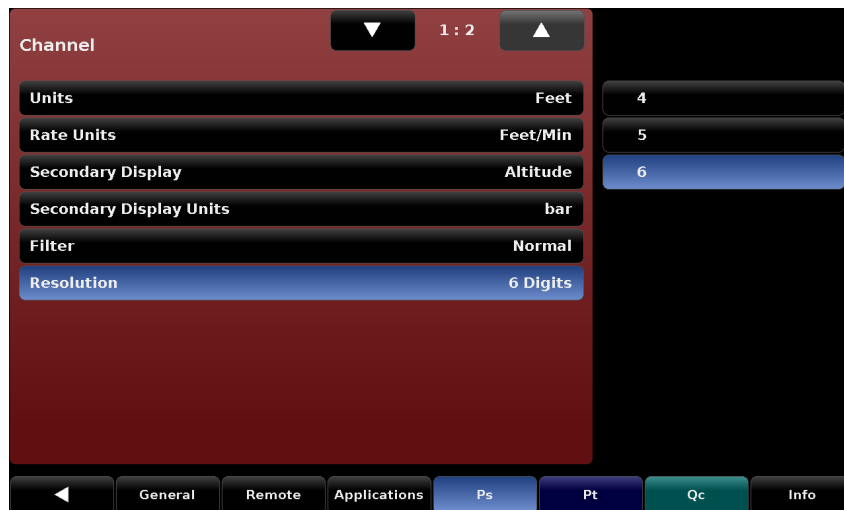

Figure 7.3.6 - Resolution, [Ps] / [Resolution] / [6]



### 7.3.7 Negative Qc Limits

The Negative Qc Limits setting is only applicable to the Qc Channel. It is a setting designed to protect external transducers or indicators that may be damaged by an excessive negative Qc Pressure. According to the equation,  $Q_c = P_t - P_s$ , a negative Qc will result if the  $P_s$  is greater than the  $P_t$ . Set the Negative Qc Limit to a value that will not harm external components. If this limit is reached, then a valve will open between the  $P_s$  and  $P_t$  channels to equalize the pressure. The units for the Negative Qc Limit will be the unit chosen for the Qc Channel, except while in Mach units, in which case pressure units will be used. While in other airspeed units with TAS (true airspeed) enabled, the value will be set relative to sea level.



Figure 7.3.7 - Negative Qc Limits

### 7.3.8 Qc Reference

The Qc Reference controls the internal pneumatic connection to the reference side (low pressure side) of the Qc transducer. This setting is accessed in the Setup [  ] / [Qc] / [Qc Reference] menu. Setting to [Ps] will pneumatically connect the Qc Reference to the Ps transducer. Setting to [Rear Panel] will pneumatically connect the Qc reference to the rear panel port. Choosing rear panel isolates the Qc channel from the Ps channel. This is useful when calibrating an airspeed indicator at current atmospheric pressure or when calibrating the Qc transducer.

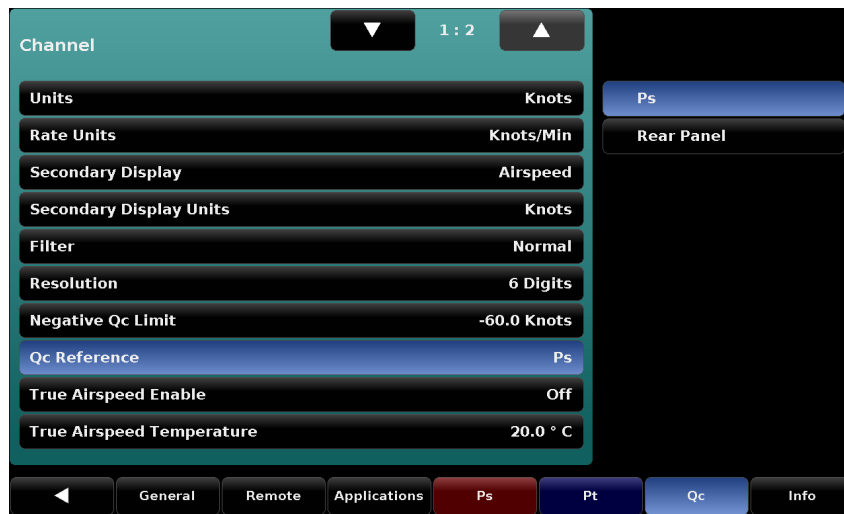



Figure 7.3.8 - QC Reference

### 7.3.9 True Airspeed Enable

In order to display True Airspeed instead of Indicated Airspeed the True Airspeed setting must be turned [On] by accessing the Setup [  ] / [Qc] / [True Airspeed Enable] screen. True Airspeed is a calculated value that adjusts for the air density around the aircraft. True airspeed is an indication of the speed of the aircraft relative to the air mass in which it is flying. True Airspeed can only be enabled while in “Ps/Qc Air Data” mode. While not in this mode, True Airspeed will be unavailable.

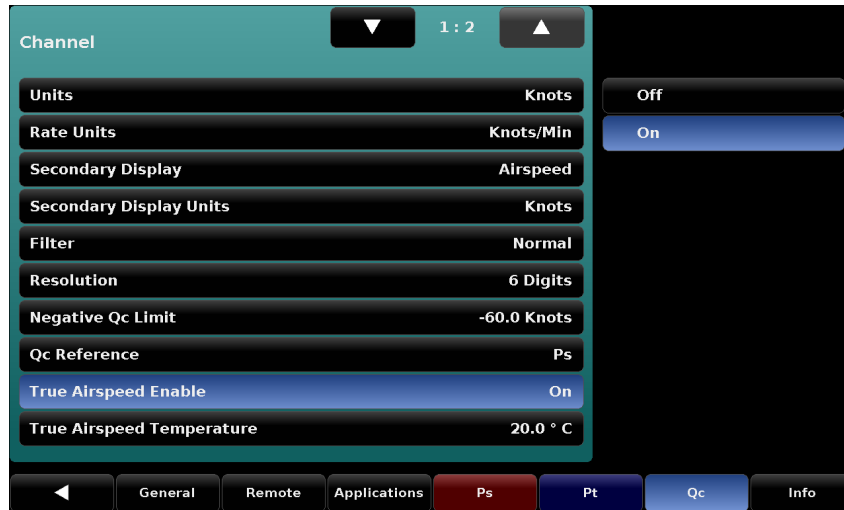

Figure 7.3.9 - True Airspeed Enable

### 7.3.10 True Airspeed Temperature





True Airspeed is a calculated value that adjusts for the air density around the aircraft. The ratio between pressure and density is temperature dependent. To calculate True Airspeed the temperature must be entered in the Setup [  ] / [Qc] / [True Airspeed Temperature] screen.



Figure 7.3.10 - True Airspeed Temperature

**7.3.11 Maximum Limits and Minimum Limits**

The second page of the Setup [  ] / [Ps], [Pt] or [Qc] menu can be accessed by touching the Down Arrow [  ] on the first page. The first button on the “Limits” page of the setup screen is [Maximum Limit], the second is [Minimum Limit].

The [Maximum Limit] and [Minimum Limit] buttons accessed under the Setup [  ] / [Ps], [Pt] or [Qc] / Page Down [  ] screen provides a place to limit the setpoints that can be chosen in the main screen. These limits can only be set within the range of the channel’s transducer. The minimum limit must be lower than the maximum limit. The operator cannot enter setpoints and thereby not control to values outside of these limits. The current limit is shown with a blue background. Set each Limit by selecting a numeric entry that falls within the limits shown on the numeric keypad.



For the engineering unit Mach, the Qc maximum limit and minimum limit are to be set for sea level (Ps at atmospheric pressure). The Qc maximum and minimum limit will change dynamically based on the input values as the Ps pressure changes. |

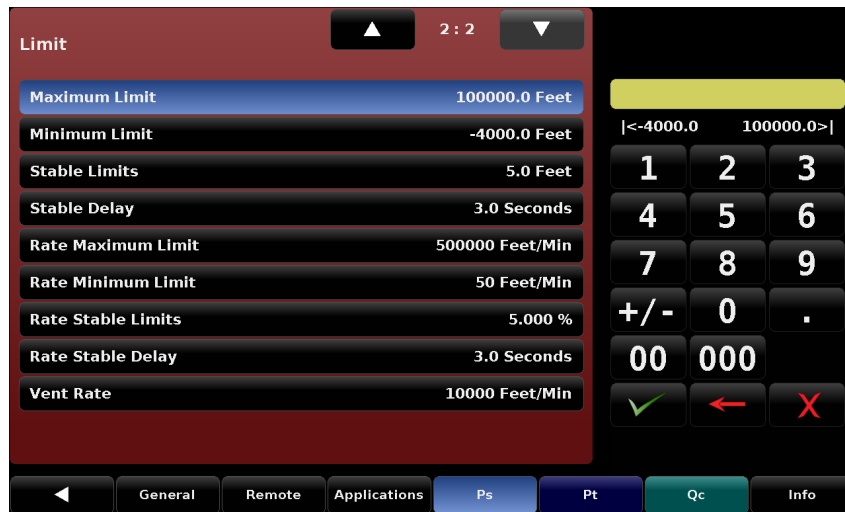

**Figure 7.3.11a - Maximum Limits (Ps Altitude Channel)**



Figure 7.3.11b - Minimum Limits (Ps Altitude Channel)

### 7.3.12 Stable Limits and Stable Delay

The [Stable Limits] and [Stable Delay] parameters set the limits that must be satisfied for the controller channel to display a stable condition. The [Stable Limits] setting defines a +/- numeric window (in the current units of measure), centered at the setpoint. The [Stable Delay] setting defines a time duration. **A stable condition exists when the pressure sensed by the channel's transducer is within the stable window for a time duration equal to the stable delay.** A stable condition is indicated when the pressure, altitude or airspeed reading turns green. A stable indication is displayed in control, measure or vent mode.

The settings are accessed in the Setup [⚙️] / [Ps], [Pt] or [Qc] / [Stable Limit] and [Stable Delay] menus. The currently selected limit is shown with a blue background. Figures 7.3.12a and 7.3.12b show Stable Limits and Stable Delay buttons selected in the Ps channel, Pt and Qc channels will have their own limits but the layout is the same.

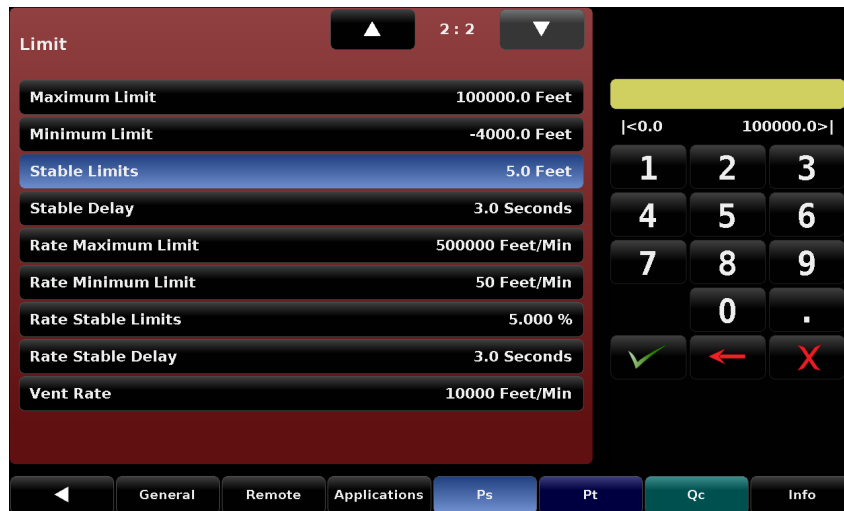

Figure 7.3.12a - Stable Limits (Ps Altitude)

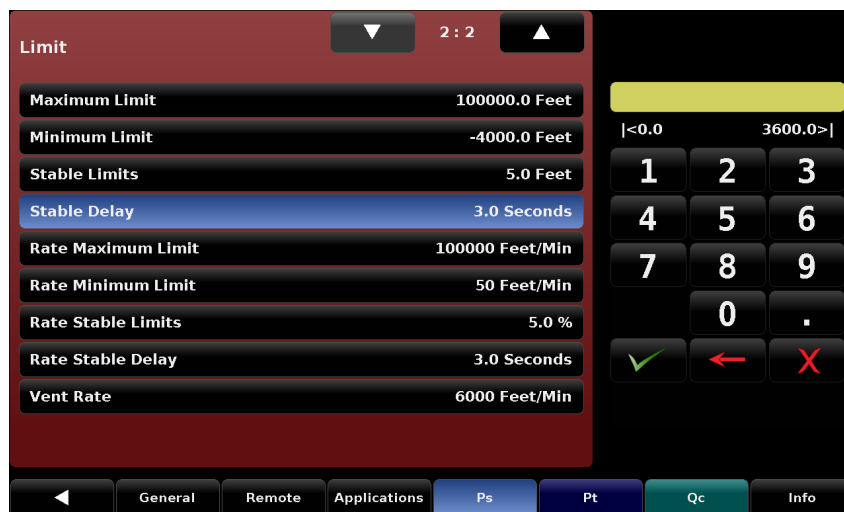
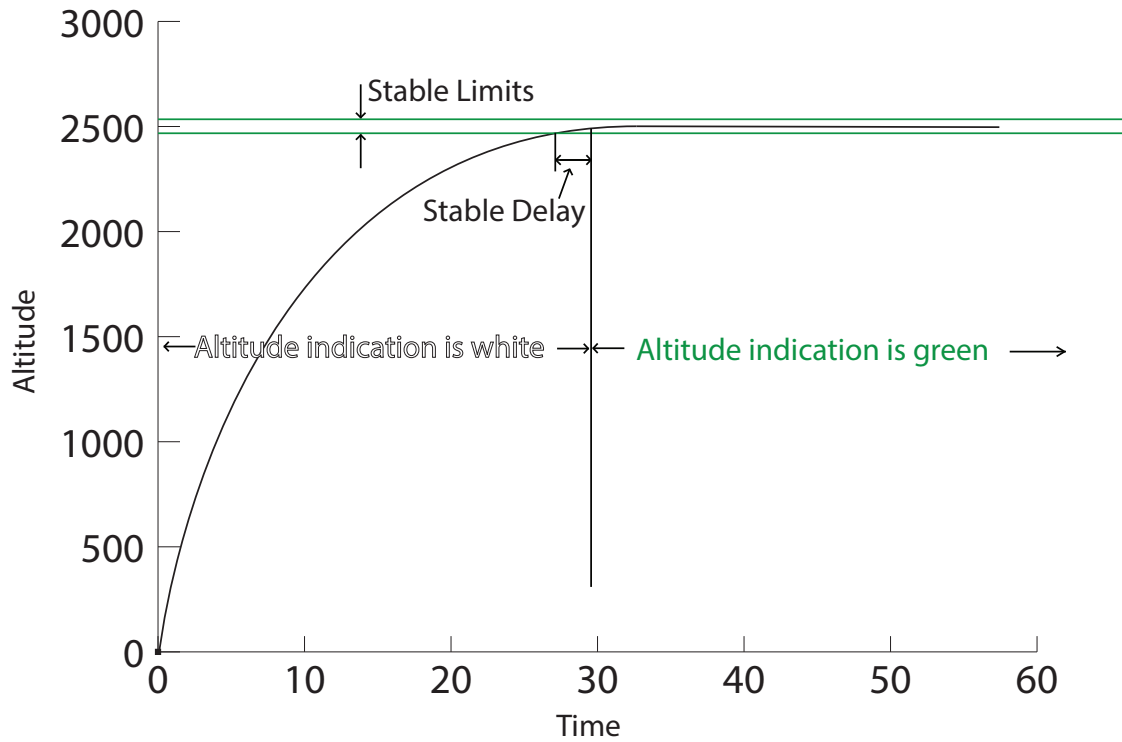



Figure 7.3.12b - Stable Delay (Ps Altitude)

Figure 7.3.12c illustrates how the Stable Limits and Stable Delay parameters work in practice.



**Figure 7.3.12c - Illustration of Stable Limit and Stable Delay**

### 7.3.13 Rate Maximum Limits and Rate Minimum Limits

The [Rate Maximum Limit] and [Rate Minimum Limit] buttons accessed under the Setup [  ] / [Ps], [Pt] or [Qc] / Page Down [  ] screen provides a place to limit the rate setpoint that can be chosen within a channel.

The [Rate Minimum Limit] can be set at or above a predetermined point for each channel. Above this minimum value the controller can achieve its specified rate stability while ramping up to a control setpoint if external volumes and vacuum pump specifications conform to those specified in Section 4 - Specifications. The [Rate Maximum Limit] also has a predetermined rate above which it cannot be set, but high rates are also limited by the capacity of the external vacuum pump, the external volume attached to the measure control port and the altitude setpoint among others. The controller can, therefore, be set to a rate that it will never be able to achieve. However this high rate limit is available to provide the operator the ability to control from one setpoint to another as quickly as possible given external limitations.

The Rate Minimum Limit must be lower than the Rate Maximum Limit. The operator cannot enter rate setpoints and thereby not control to rate values outside of these limits. The current rate limit is shown with a blue background. Set each Limit by selecting a numeric entry that falls within the limits shown on the numeric keypad.

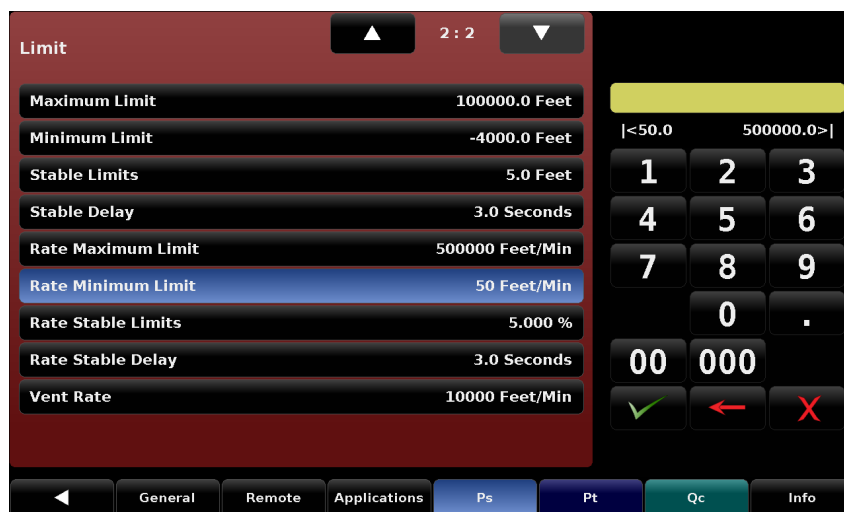
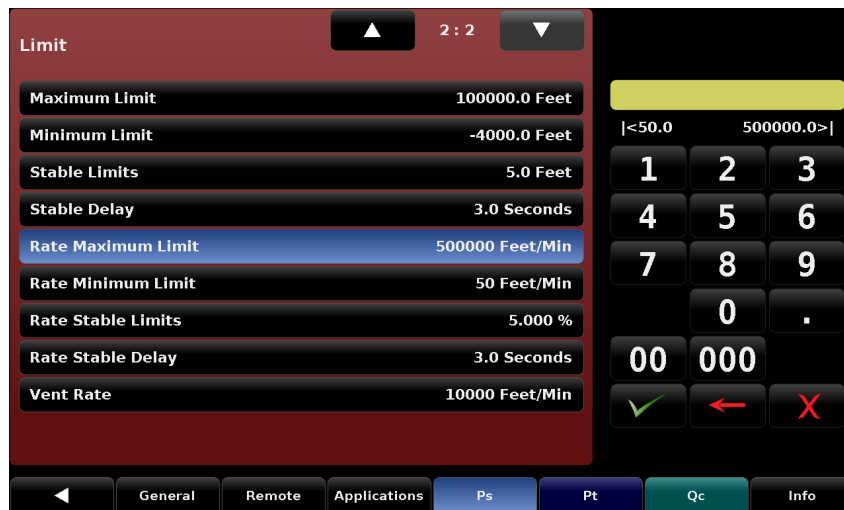

Figure 7.3.13 - Rate Max Limit and Rate Min Limits

**7.3.14 Rate Stable Limits and Rate Stable Delay**

The [Rate Stable Limits] and [Rate Stable Delay] parameters set the limits that must be satisfied for the rate in each channel to display a stable condition. The [Rate Stable Limits] setting defines a +/- percent of reading rate window, centered at the rate setpoint. The [Rate Stable Delay] setting defines a time duration. **A stable rate condition exists when the rate of change sensed by the channel's transducer is within the Rate Stable Limits window for a time duration equal to the Rate Stable Delay.** A stable condition is indicated when the pressure rate, altitude rate or airspeed rate reading turns green. A stable indication is typically displayed in control mode while controlling to a setpoint.

The settings are accessed in the Setup [⚙️] / [Ps], [Pt] or [Qc] / [Rate Stable Limit] and [Rate Stable Delay] menus. The currently selected limit is shown with a blue background. Figures 7.3.14a and 7.3.14b show [Rate Stable Limits] and [Rate Stable Delay] buttons selected in the Ps channel, Pt and Qc channels will have their own limits but the layout is the same.



**Figure 7.3.14a - Rate Stable Limits (Ps)**

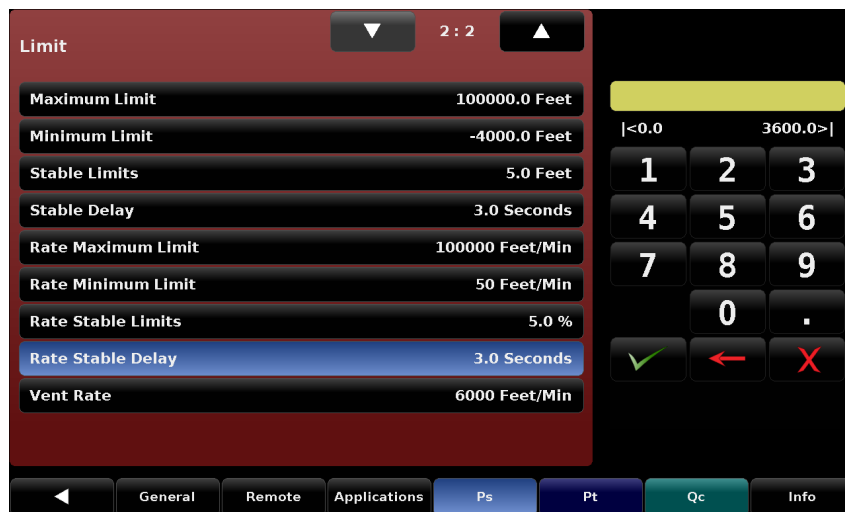

**Figure 7.3.14b - Rate Stable Delay (Ps)**



### 7.3.15 Vent Rate (Go-To-Ground parameters)

The CPA8001 Air Data Test Set has a built in Go-To-Ground feature. Each channel will always vent at a controlled [Vent Rate] through the internal regulator to protect connected devices that may be sensitive to rapid changes in pressure. The [Vent Rate] for the Ps, Pt or Qc channels can be set with the Setup [  ] / [Ps], [Pt] or [Qc] / [Vent Rate] button.

At 1 mbar from ambient atmospheric pressure the unit will switch from the controlled vent to a direct vent out through a solenoid valve and a 0.0079 inch diameter orifice. Figure 7.3.15 shows the [Vent Rate] screen for the Ps channel.

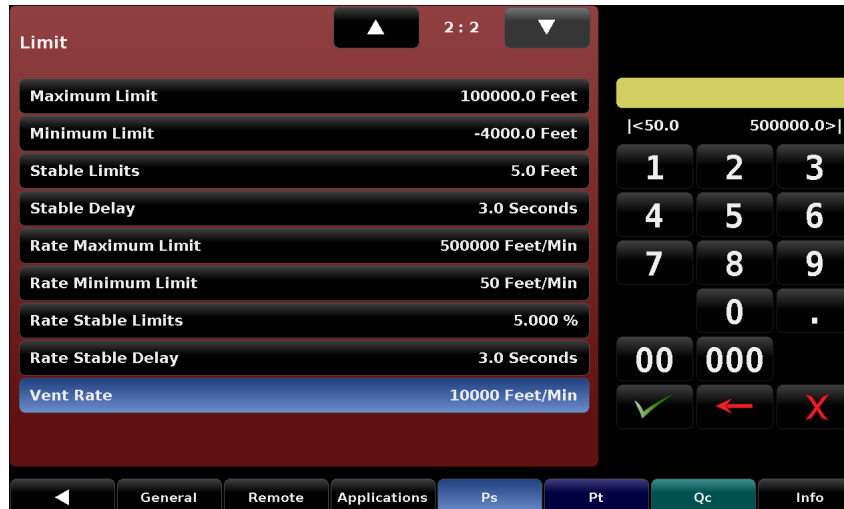



Figure 7.3.15 - Vent Rate (Ps)

## 7.4 Applications

Press the [Applications] tab in the Setup [  ] screen and a screen will appear containing various labeled icons that when pressed access other screens that provide the following functions:

- Calibration of internal transducers
- Sequence program configuration
- Selection of favorites viewable in the local operation screen
- A troubleshooting screen that displays errors and remote command and response echoing
- Tuning screens for the Ps, Pt/ Qc channels
- An administration screen used to change passwords
- A software update screen

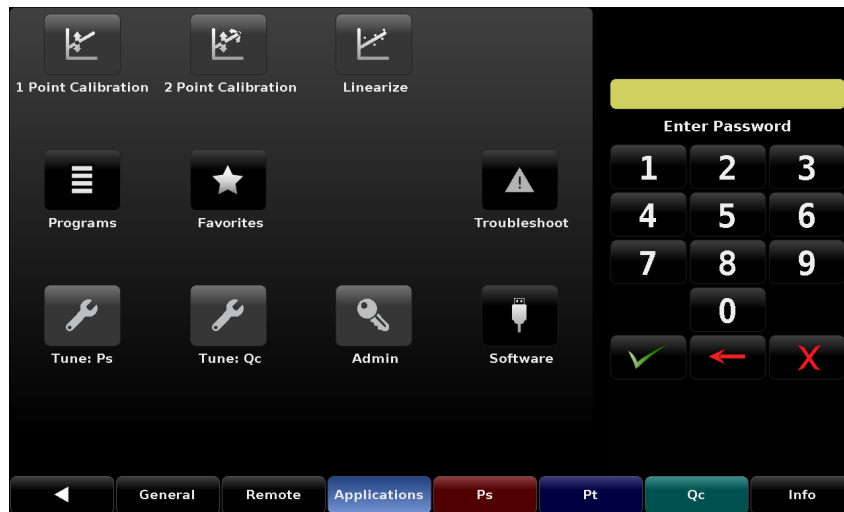

Figure 7.4 - Applications (Locked)

### 7.4.1 Passwords

All the Calibration screens ([1 Point Calibration] [2 Point Calibration] and [Linearize]) are password protected with the “calibrate password”. The “Admin/Service Passwords” allows access to the Service screens ([Tune Ps], [Tune Qc/Pt], and [Admin]). Figure 7.4.1 shows the [Applications] screen when unlocked by both the calibration and Admin/Service Passwords.



Notice

**The Default Passwords sent with the instrument are as follows:**

**Calibration Password: 123456**

**Admin/Service Password: 987654**

**Both passwords can be changed and saved in the [Admin] page within the [Setup] [  ] / [Applications] section.**

**If the passwords are changed then forgotten contact Mensor or your local Mensor service center for instructions to access the protected areas and to reset the passwords.**

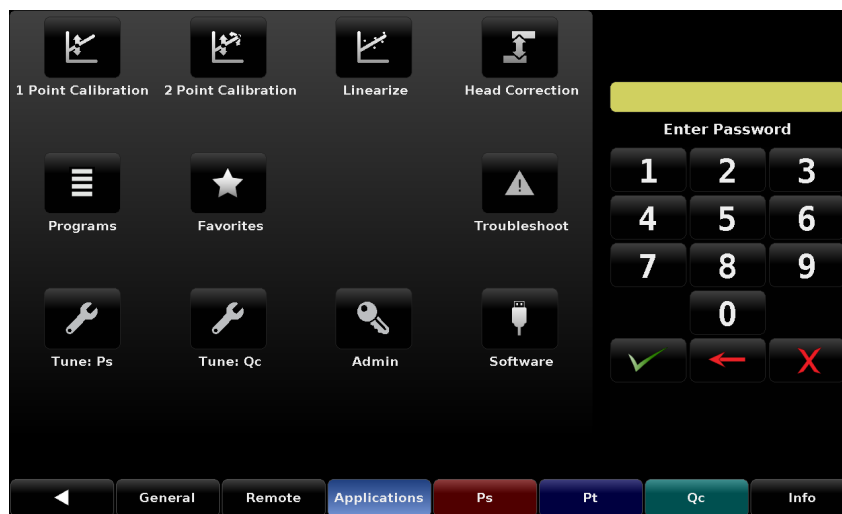

**Figure 7.4.1 - Applications tab (Unlocked)**

### 7.4.2 Calibration - Guidelines

The top row of labeled icons in the [Applications] screen are the password protected applications for calibration of the CPA8001 Transducer Module. Calibration can be performed by the owner of the instrument or sent back to Mensor for a ISO-17025, A2LA accredited calibration.



**NOTICE: During the first re-calibration at the Mensor factory a service file is started in which every calibration and all extra services are recorded.**

Notice

This section is included for those who wish to calibrate their CPA8001 within their own calibration lab. Because calibration involves special training and calibration components that are not addressed here, only personnel qualified in calibration procedures should be allowed to calibrate the CPA8001.



Caution

**CAUTION! Only qualified personnel should be allowed to calibrate the CPA8001.**

A Mensor recommended calibration setup is addressed in [Section 7.4.2.4, Calibration Setup](#). The CPA8001 pressure reading is automatically adjusted for the effects of temperature and non-linearity within the calibrated temperature range of 15-45°C. The process is referred to as dynamic compensation because each reading is adjusted before it is output to the display or to a communication bus. Thus, a calibrated CPA8001 operated within its temperature band, and with proper zero and span adjustments, will provide accurate pressure measurements.

The CPA8001 should have the calibration verified periodically to insure its stability. Initially, the recommended period between calibration is one year. This period may be extended as confidence is gained in the span stability.

#### 7.4.2.1 Calibration Environment

For maximum accuracy, allow the CPA8001 to warm up for a minimum of 60 minutes in an ambient temperature within the compensated range prior to commencing a calibration. In addition the instrument should be at rest on a stable platform that is free of excessive vibration and shock.

#### 7.4.2.2 Calibration Pressure Standards

Mensor recommends the use of appropriately accurate pressure standards when calibrating this instrument. Such standards should be sufficient so that when the techniques of the ISO Guide to the Expression of Uncertainty in Measurement (GUM) are applied, the instrument meets its accuracy statements as required by ISO/IEC 17025:2005, or other applicable standards.

#### 7.4.2.3 Calibration Media

Gas media are required for calibration. The recommended medium is dry nitrogen or clean, dry, instrument air.

### 7.4.2.4 Calibration Setup

Refer to the calibration setup illustration on the following page (See Figure 7.4.2.4 - Calibration Setup). The illustration shows a typical calibration setup for absolute and gauge pressure instruments.

The 'Pressure Standard' is normally a deadweight tester, a precision piston balance or a precision manometer. The 'Volume Controller' refers to a hand operated variable-volume pressure vernier device. A diaphragm type vacuum gauge is recommended over the gauge tube type of vacuum transducer for calibrating sub-atmospheric pressures (shown in the illustration under "Setup for Absolute Pressure"). A vacuum source with a capacity to generate 600 mTorr absolute is recommended.

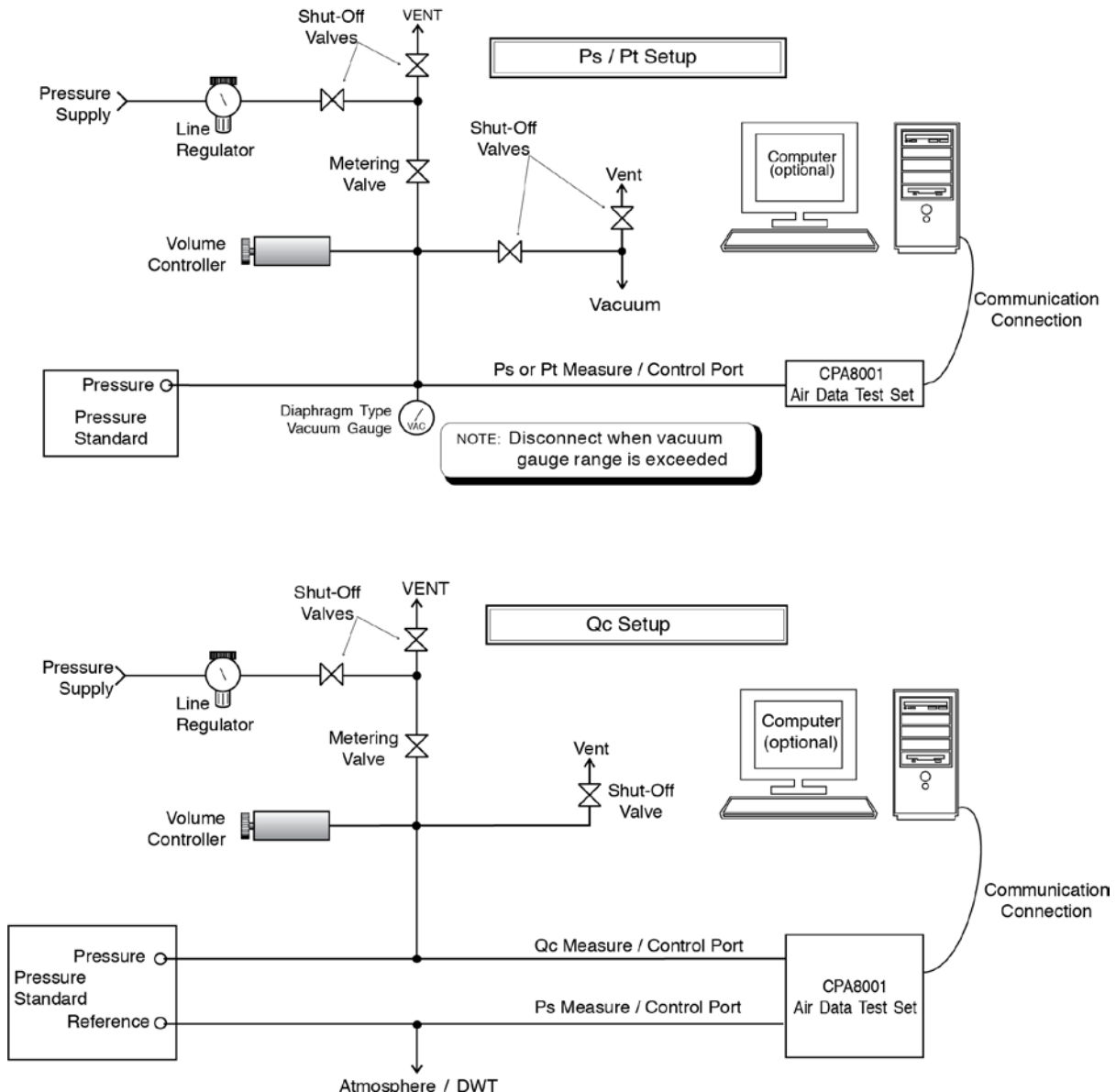



Figure 7.4.2.4 - Calibration Setup



Notice

**Ps must see the same pressure as Qc reference for the common mode to work correctly. When performing a dual deadweight calibration, the reference pressure cannot exceed the range of Ps. During the calibration of the Qc transducer, the Ps channel should be connected to the Qc reference. Qc reference option should have Ps selected.**

### **7.4.3 Calibration Procedures**

All calibration screens can be accessed in the Setup [  ] / [Applications] area. To access these screens a password must be entered, See [Section 7.4.1](#) for the default password. There are three methods used to calibrate transducers in the CPA8001 transducer module. A simple [1 Point Calibration] can be used to adjust a single point (usually the zero point). A [2 Point Calibration] extends this capability to adjust two points (usually points close to the Zero and Span). The [Linearize] calibration provides a way to calibrate and linearize the pressure curve using from 3 to 11 points over the range of each transducer. Before calibrating any transducer, ensure the DUT is level with the instrument. Procedures for use and interaction with all the calibration screens can be found in the following sections of this manual:

- 1 Point Calibration — [See Section 7.4.3.1](#)
- 2 Point Calibration — [See Section 7.4.3.2](#)
- Linearize Calibration — [See Section 7.4.3.3](#)

### 7.4.3.1 1 Point Calibration

The 1 Point Calibration screen provides a place to calibrate an internal transducer, the vacuum reference transducer or the optional barometer using a single pressure point. This is usually done to adjust the zero range of a transducer. The transducer being calibrated is chosen by pressing the [Ps], [Pt], [Qc], [Vacuum] or [Barometer] tab at the bottom of the screen (see figure 7.4.3.1a below). The transducer currently chosen for calibration will have a blue gradient background. Displayed at the top of this screen is the transducer's serial number and its pressure range showing the pressure unit that was most recently chosen for that transducer (calibrations cannot be performed using avionics units).

**Complete the steps below to calibrate the zero of a Qc transducer (example 0 ... 34 in Hg):**

1. Select the Qc transducer by pressing the [Qc] button at the bottom of the screen.
2. Press the [Vent] button.
3. After the pressure stabilizes, press the [New Value] button, this will open a numeric keypad where "0" can be entered as the reference value and accepted by pressing the check [  ] mark.
4. Limits for the reference value will be displayed above the keypad. A certificate number can be entered by pressing the [certificate] button. The date can be entered by pressing the [Date] button. The calibration interval can be viewed and changed by pressing the [Interval] button.
5. Press the [Save] button to complete the 1 Point calibration.
6. The factory calibration settings for the transducer can be restored by pressing the [Restore Factory] button. This would overwrite the current calibration performed.

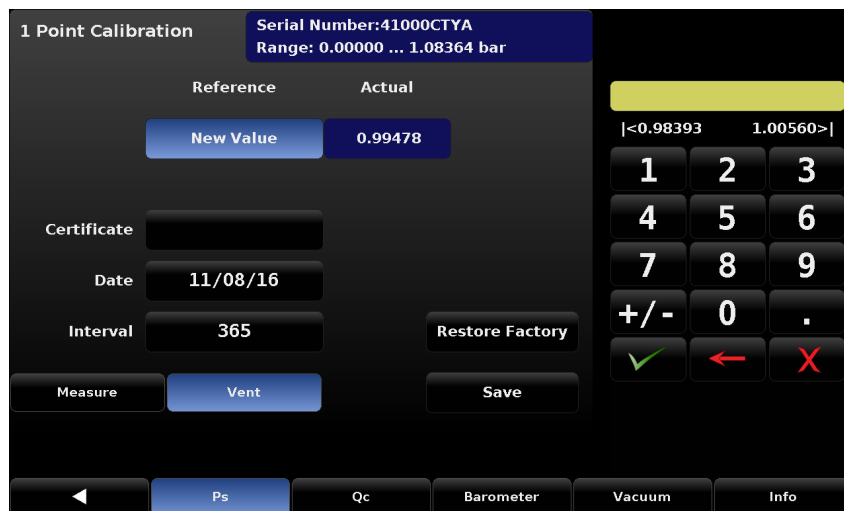

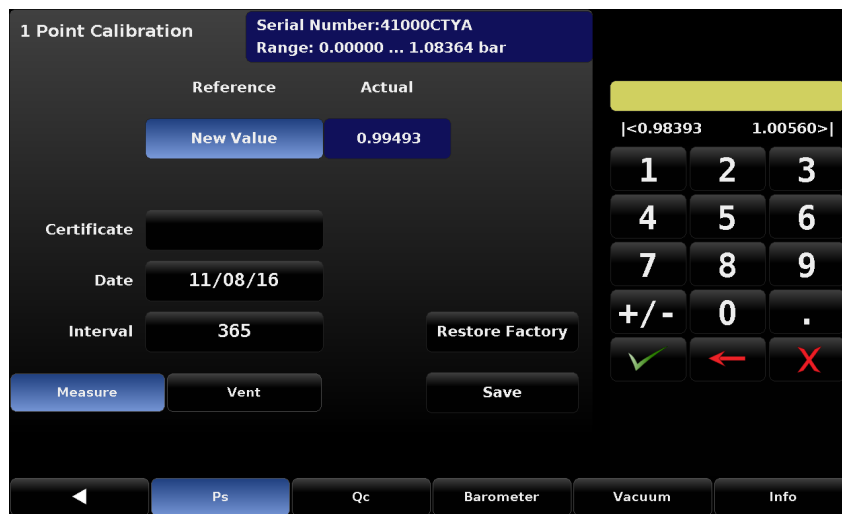

Figure 7.4.3.1a - 1 Point Calibration for Qc in [Vent] mode with [New Value] button pressed

**Complete the steps below to complete a 1 Point calibration of a Ps, Pt or Barometric transducer.**

1. Select [Ps], [Pt] or (optional) [Barometer] from the button of the 1 Point Calibration Screen. See figure 7.4.3.1b below.
2. Press the [Measure] button.
3. Connect a high accuracy reference standard capable of measuring absolute pressure to the Measure/Control port of the transducer channel being calibrated or, in the case of the Barometer, connect to the barometer barb fitting on the back of the instrument.
4. A vacuum pump can be connected in addition to a high accuracy reference standard for generating the appropriate sub-atmospheric pressure.
5. Generate a pressure close to the minimum range. For Ps and Pt, Mensor recommends a value between 600 mTorr absolute and 20% of the transducer's span. For the Barometer, a minimum calibration point corresponding to the original calibrated minimum range of 8 psia is recommended for barometers.
6. After the pressure stabilizes, press the [New Value] button, this will open a numeric keypad where the "Actual" value from the pressure standard can be entered and accepted by pressing the check [  ]. Limits for the reference pressure will be displayed above the keypad.
7. A certificate number can be entered by pressing the [certificate] button. The date can be entered by pressing the [Date] button. The calibration interval can be viewed and changed by pressing the [Interval] button.
8. Press the [Save] button to complete the 1 Point Calibration.
9. The factory calibration settings for the transducer can be restored by pressing the [Restore Factory] button. This would overwrite the current calibration performed.

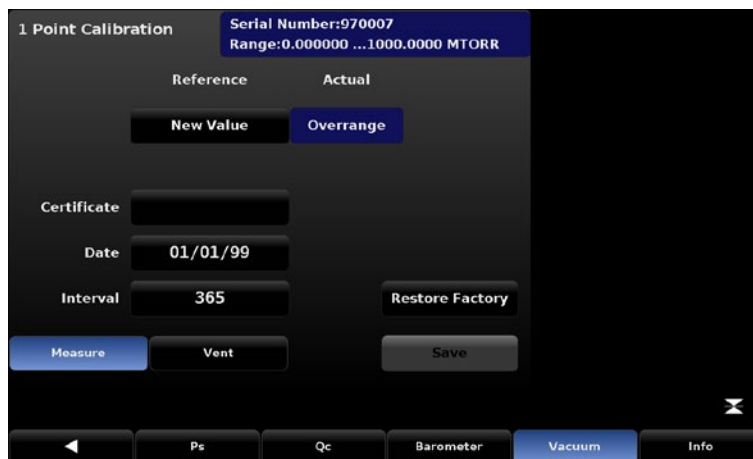

**Figure 7.4.3.1b - 1 Point Calibration [Ps]**



**Complete the steps below to complete a 1 Point calibration of vacuum transducer.**

1. Run the “Zero Bleed Sequence” from the [Home]/[Favorites] tab as explained in section 6.2.14, Vacuum Setting.
2. Connect a high accuracy transducer to the back of the instrument on the small vacuum reference transducer port (this may require installing a barb fitting).
3. Pump down the vacuum to ensure the vacuum is successfully set within the 400 - 700 mtorr range. This can be tuned by adjusting the vacuum bleed valve (section 6.2.14).
4. Select [Vacuum] from the button of the 1 Point Calibration Screen.
5. Press the [New Value] button, this will open a numeric key pad where the “Actual” value from the pressure standard can be entered and accepted by pressing the check [  ]. mark. Limits for the reference pressure will be displayed above the keypad.
6. A certificate number can be entered by pressing the [certificate] button. The date can be entered by pressing the [Date] button. The calibration interval can be viewed and changed by pressing the [Interval] button.
7. Press the [Save] button to complete the 1 Point Calibration.
8. The factory calibration settings for the transducer can be restored by pressing the [Restore Factory] button. This would overwrite the current calibration performed.

**Figure 7.4.3.1c - 1 Point Calibration [Vacuum]**

### 7.4.3.2 2 Point Calibration

A 2 Point Calibration adjusts both the offset and the slope of the active transducer. This is accomplished by interacting with the “2 Point Calibration” screen (See Figure 7.4.3.2).

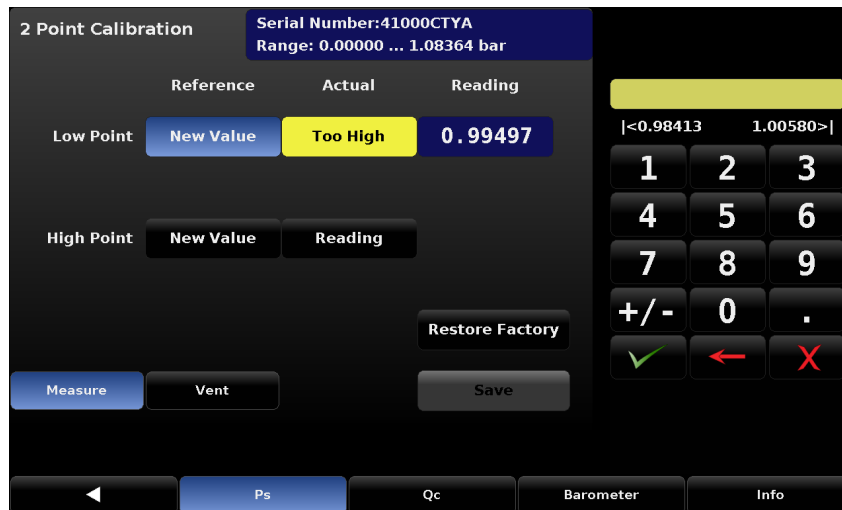

**Figure 7.4.3.2 - 2 Point Calibration**

**Complete the steps below for a complete 2 Point Calibration:**

1. Select [Ps], [Pt], [Qc] or (optional) [Barometer] from the button of the 2 Point Calibration Screen. See figure 7.4.3.2.
2. To calibrate the “Low Point”:
  - The Measure /Control port of the transducer’s channel should be supplied with a suitable, “low point” pressure (see [Section 5.6, Pneumatic Connections](#), for the transducer port location).
  - For a Qc (differential) transducer, this low point pressure can be achieved by Pressing the [Vent] button on the 2 Point calibration screen and wait for the reading to stabilize at, or close to, zero.
  - For a Ps or Pt (absolute) transducer a suitable source of vacuum should be applied to the Measure/Control port of the transducer’s channel along with a high accuracy vacuum standard. Otherwise, a pressure calibration standard, capable of generating and measuring a pressure value, should be connected to the Measure/Control port of the transducer’s channel. In either case the pressure should be measured at a stable value that is between 600 mTorr absolute and within 20% of the range of the selected transducer. In Figure 7.4.3.2 the pressure at the Measure Control is “Too High” as indicated.
  - Press the [New Value] button and, via the numeric key pad, enter the reference pressure obtained from the calibration standard or enter zero (“0”) if calibrating Qc in a vented state. After the value has been accepted by pressing the check [✓] mark on the numeric key pad the value will appear with a green background where the [New Value] button was. When the pressure is stable the [Reading] button, under the “Actual” label and on the row labeled “Low Point”, should be pressed. This action accepts the current measured reading and it will appear with a green background where the [Reading] button was. These actions complete the low point calibration.
3. To calibrate the “High Point”:
  - The “High Point” Calibration is done in a similar way as the “Low Point” but should be performed in [Measure] mode.
  - Place the instrument in Measure mode by pressing the [Measure] button within the 2 Point Calibration Screen.

- Supply a pressure to the Measure/Control Port using a pressure standard. This pressure should be as close as possible to the full scale value of the selected transducer or at least within 20% of that value. The [Too Low] button will change to a [Reading] button when the pressure reaches an acceptable range.
- After the pressure stabilizes, select the [Reading] button to accept the instrument's reading of the pressure input. The actual reading will appear within a green background where the [Reading] button was.
- Press the [New Value] button and, via the numeric key pad, enter the reference pressure obtained from the calibration standard. This value is obtained from the pressure measured by the calibration standard. After the value has been accepted by pressing the check [  ] mark on the numeric key pad the value will appear with a green background where the [New Value] button was. These actions completes the High Point calibration.
- The [Save] button will now be active, press it to store the values in the transducer.

### 7.4.3.3 Linearize

The [Linearize] application (See figure 7.4.3.3a) provides a place to record [As Found] calibration data and to linearize each internal transducer in the CPA8001 using that data. An “as found calibration” can be performed by connecting a suitable pressure standard to the transducer channel's Measure/Control port, placing the channel in [Measure] mode and supplying from 3 to 11 pressure points within the range of the transducer being calibrated. The record of the pressures generated or measured by the pressure standard and the corresponding reading from the instrument's transducer can be recorded and transcribed into the [Linearize] / [As Found] screen. The screen is accessed by pressing the [As Found] button in the [Linearize] screen.

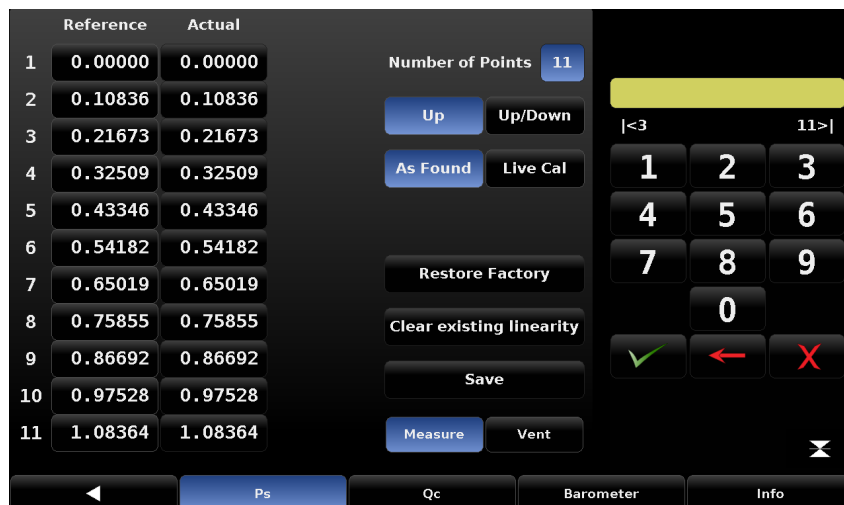

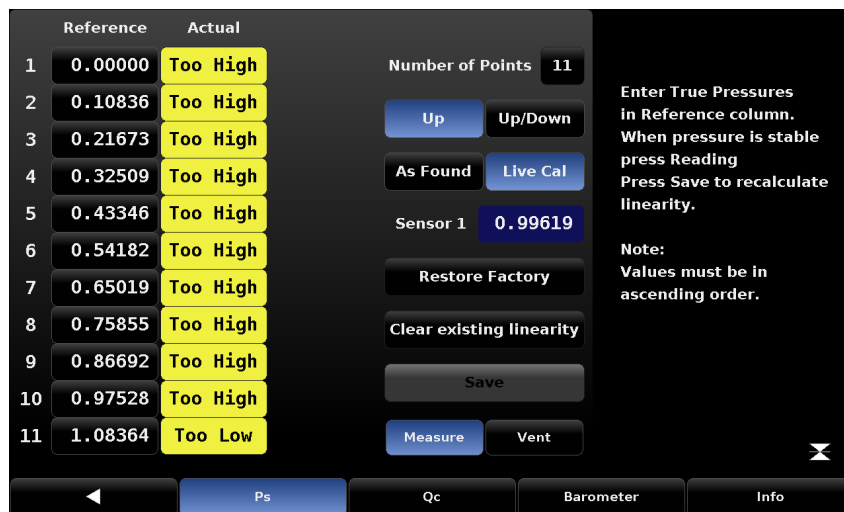

Figure 7.4.3.3a - Linearize / As Found

In the [Linearize] / [As Found] screen choose the transducer to be linearized by pressing the [Ps], [Qc], [Pt], or [Barometer] button. Pressure test points generated by the reference standard are entered in the column labeled “Reference”; each of the corresponding readings from the instrument's transducer should be entered into the column labeled “Actual”. To enter readings, simply press the corresponding point in the “Reference” or “Actual” columns and a data entry keypad will appear on the side bar. Enter and accept the point using the key pad and check [  ]. Pressing the [Save] button linearizes the internal transducer based on the “As Found” data entered.

Linearization can also be accomplished for each transducer in a “Live Calibration” by pressing the [Linearize] / [Live Cal] button (See figure 7.4.3.3b). The Live Cal allows the calibration technician to perform the calibration and linearization for each transducer in a more direct way. In the Live Cal, the reference standard is connected to the transducer channel’s Measure/Control port and the CPA8001 channel is placed in Measure mode. Choose the transducer to be linearized by pressing the [Ps], [Qc], [Pt], or [Barometer] button. The reference pressure generated by the standard is recorded in the “Reference” column for each point. The reading of the internal transducer for each pressure point can be seen directly in the “Sensor1” reading window. Pressing the corresponding point under the “Actual” column will accept that reading into that point. Subsequent pressure points generated by the reference standard are accepted and recorded in the same way. The points should be roughly 10% apart and in increasing pressure order from 1 to 11.

After all points are entered, press the [Save] button to linearize the internal transducer based on the “Live Cal” data.



**Figure 7.4.3.3b - Live Cal**

At any time the [Factory Cal] button can be pressed to revert back to the factory calibration.

### 7.4.4 Programs

The Setup [  ] / [Applications] / [Programs] screen is used to create, view and edit programs that are used to automatically run a sequence of commands within the CPA8001. There are two tabs at the bottom of the Program screen shown in figure 7.4.4a. The Display tab provides a place to view each program. Pressing the program label (program selection button) at the top left will allow selection of alternative programs from the side bar.



Figure 7.4.4a - [Programs] / [Display]

With the [Edit] tab selected (figure 7.4.4b) the operator can edit existing programs or create new ones. Pressing a Command or Data point will present the available commands, or a data entry screen on the side. Selection of commands and data in each sequential line will change and save the resulting command sequence in the selected program. By pressing the screen title in the upper left corner of the screen, the title can be changed.

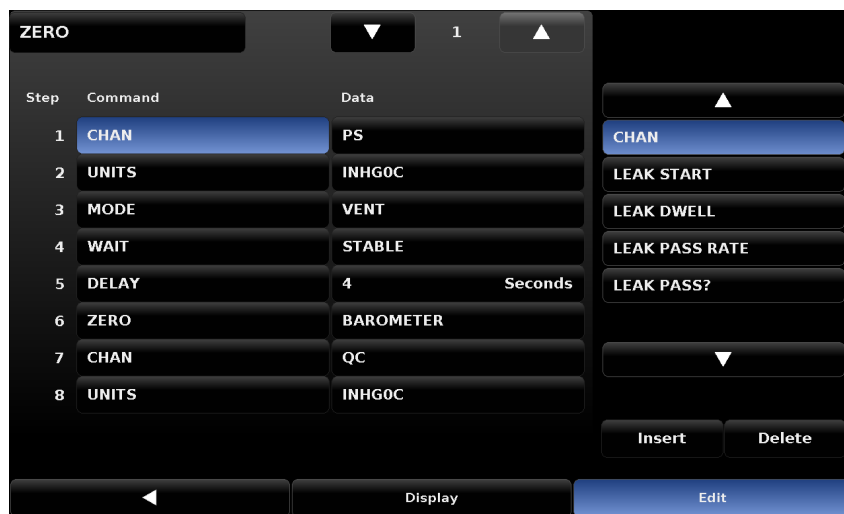

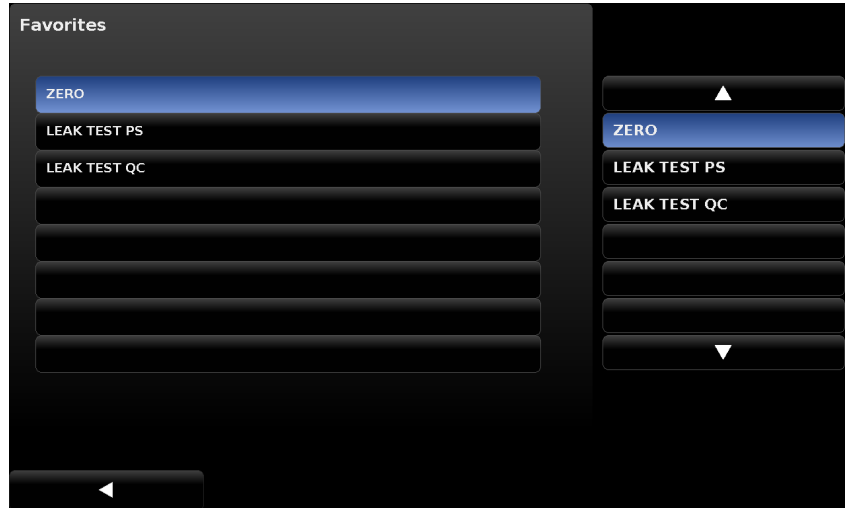

Figure 7.4.4b - [Programs] / [Edit]

### 7.4.5 Favorites

The Setup [  ] / [Applications] / [Favorites] screen is used to select programs that will appear in the main screen when the Favorites [  ] icon is pressed. The current list of favorites is shown in figure 7.4.5 on the left. Press one of these and then press the available programs on the right to update the current favorites list with that program.



**Figure 7.4.5 - Favorites**



### 7.4.6 Troubleshoot

The Setup [  ] / [Applications] / [Troubleshoot] screen provides a list of internal or remote errors that may have occurred. Figure 7.4.6 below gives an example where the CPA8001 access door has been opened. Once the errors have been viewed in this screen, they are cleared from the remote queue and the error icon indication will disappear. The [Remote] tab shows all remote communication that has occurred from one of the remote communication ports and is helpful in de-bugging remote control software programs.



**Figure 7.4.6 - Troubleshoot**

### 7.4.7 Admin

The Setup [  ] [Applications] [Admin] Screen has a place to change the Calibration and Admin/Service Passwords. Press the [Change Password...Calibrate] button to enter a new password, and then accept by pressing the Check [  .] button. The same procedure applies to the [Change Password ...Service] button.

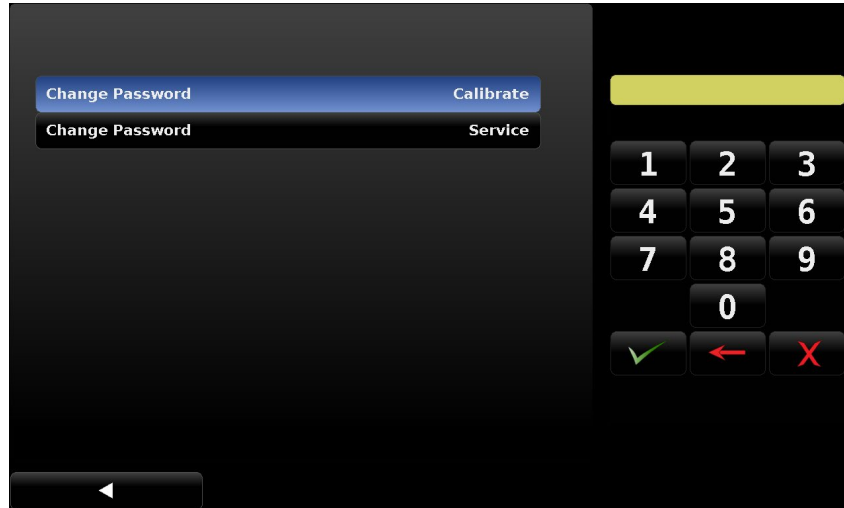



Figure 7.4.7 - Change Password

### 7.5 Info Tab

After the instrument has been powered on and the main screen is displayed press the Setup [  ] key and then press the [Info] tab. Information displayed will be the Mensor contact address information, the instrument's serial number, firmware version and a list of the integrated transducers and other information.

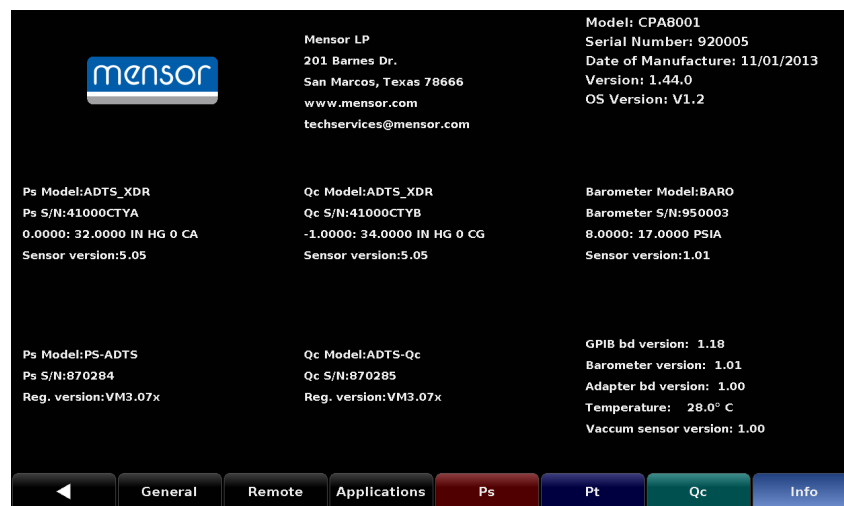

Figure 7.5 - Info Tab

## **8. Remote Operation**

### **8.1 Software/Functions**

When the instrument is turned on it takes about 40 seconds to complete the initialization. The BIOS routines test the system CPU board, then the operating system. The system will go through software and hardware initialization. The following hardware/software is initialized:

Transducers: The system is scanned for installed transducers and all operating transducers are initialized. The transducer(s) RAM data is transferred to system RAM where appropriate.

GPIB: The GPIB board is initialized as a talker/listener.

Units: The scale factors for percent full scale and counts are calculated.

Serial: The external serial port is initialized.

Valves: The pressure control algorithm is initialized.

Options: Any optional hardware/software is initialized.

Interrupts: Interrupt vectors are loaded and enabled.

After initialization, the program enters a polled loop.

The proprietary calibration constants and current settings are stored in a non-volatile device.

### **8.2 Remote Command Set**

There are various command sets available in the CPA8001, including the Mensor command set, SCPI WIKA command set, and the Ruska 6610 command set. The recommended command set for new development is the Mensor command set. All commands must be terminated with a <CR> and/or a <LF>.

All response strings are terminated with the chosen termination character. See 7.2.4 for how to choose the termination character.

For all commands (no ?), the data column represents the required parameters to be sent to the CPA8001 following the string in the command column. Any command that requires multiple parameters must have the parameters separated by commas.



**Table 8.2 - Remote Command Set**

Command/Query	Data	Function/Response
?	See table below	Returns data per the current output format
Acquire?	15 char string.  Ex:  Acquire? Test_stand_1  Returns:  Returns:  <sp>(YES or NO), CCC... CCCcr><lf>	This command is used when multiple computers would like to control the instrument.  Yes, if acquisition is successful  No, if instrument is being controlled with another computer  CCC... = name of controlling computer  See: Release? and Unlock
Address	0-31	Sets the GPIB Address
Address?	<sp> xx <cr><lf>	Returns the GPIB Address
A?	<sp>n.nnnnne+nn<cr><lf>	Returns the A channel pressure reading
AR?	<sp>n.nnnnne+nn<cr><lf>	Returns the A channel rate
ARS?	<sp>(YES or NO)<cr><lf>	Returns the A channel rate stable flag
AS?	<sp>(YES or NO)<cr><lf>	Returns the A channel stable flag
Autozero	none	Re-zero all the ranges that can read the vented pressure. These adjustments are not password protected and are not saved through power cycles. This command takes approximately 60 seconds.
Autozero?	S,T,X,X	Returns autozero data where S represents state (0 = complete, 1 = local autozero, 2 = remote autozero), T represents the estimated time to complete in seconds, and x is a (0) character since this data location is not used at this time.
Autozeroabort	none	Aborts autozero
AUX?	<sp>n.nnnnne+nn<cr><lf>	Returns the auxiliary display reading for the active channel
AUXA?	<sp>n.nnnnne+nn<cr><lf>	Returns the auxiliary display reading for channel A
AUXB?	<sp>n.nnnnne+nn<cr><lf>	Returns the auxiliary display reading for channel B
AUXPS?	<sp>n.nnnnne+nn<cr><lf>	Returns the auxiliary display reading for the Ps channel
AUXPT?	<sp>n.nnnnne+nn<cr><lf>	Returns the auxiliary display reading for the Pt channel

AUXQC?	<sp>n.nnnnne+nn<cr><lf>	Returns the auxiliary display reading for the Qc channel
AUXR?	<sp>n.nnnnne+nn<cr><lf>	Returns the auxiliary display rate reading for the active channel
AUXAR?	<sp>n.nnnnne+nn<cr><lf>	Returns the auxiliary display rate reading for channel A
AUXBR?	<sp>n.nnnnne+nn<cr><lf>	Returns the auxiliary display rate reading for channel B
AUXPSR?	<sp>n.nnnnne+nn<cr><lf>	Returns the auxiliary display rate reading for the Ps channel
AUXPTR?	<sp>n.nnnnne+nn<cr><lf>	Returns the auxiliary display rate reading for the Pt channel
AUXQCR?	<sp>n.nnnnne+nn<cr><lf>	Returns the auxiliary display rate reading for the Qc channel
Auxdisp		Set the auxiliary display function. Accepted parameters are  PRESS, UNITS = last used pressure units  AIRDATA = last used avionics units  ALTITUDE, AIRSPEED
Auxdisp?		Get the auxiliary display function
Baro?	<sp>n.nnnnne+nn<cr><lf>	Returns reading from barometric sensor
Barocaldisable	Yes,no	Not applicable to the CPA8001
Barocaldisable?	<sp>(YES or NO)<cr><lf>	Not applicable to the CPA8001
Barounits	units code or text in table below	Set the barometer's engineering units
Barounits?	<sp>CCCC<cr><lf>	Returns the barometer units in a text string
B?	<sp>n.nnnnne+nn<cr><lf>	Returns the B channel pressure reading
BR?	<sp>n.nnnnne+nn<cr><lf>	Returns the B channel rate
BRS?	<sp>(YES or NO)<cr><lf>	Returns the B channel rate stable flag
BS?	<sp>(YES or NO)<cr><lf>	Returns the B channel stable flag
Caldisable	Yes,no	Sets whether or not calibration of the active sensor is disabled.
Caldisable?	<sp>(YES or NO)<cr><lf>	Returns whether or not calibration of the active sensor is disabled.
Cerr	none	Clears the error queue
Chan	A or B	Sets the active channel on the instrument
Chan?	<sp>A or B<cr><lf>	Returns which channel is active
CID?		Returns the ID string of the regulator for the active channel
Cmdset	Mensor, SCPI, 6610	Activates remote command set for instrument emulation modes

Cmdset?	<sp>X<cr><lf>	Returns active command set identifier
Control		Instrument placed in Control Mode
Control?	<sp>(yes or no)<cr><lf>	Returns YES if instrument is in control. No if otherwise
Crate	Slow, Medium, Fast, Variable	Sets the control rate
Crate?	<sp>CCCC<cr><lf>	Returns the control rate – CCCC is variable in length and corresponds to the parameters for the CRATE command
Ctype?		Returns the type of regulator for the active channel
Decpt?	<sp>n<cr><lf>	Returns the number of decimal points for the active channel. (see Resolution)
Default	none	Sets the default values
DHCP		Reserved for DHCP setup
DHCP?		Reserved for DHCP setup
DOC	Mm/dd/yyyy	Sets the date of cal for the active transducer and turndown
DOC?	<sp>mm/dd/yyyy<cr><lf>	Returns the date of cal for the active transducer and turndown
DOM?	<sp> mm/dd/yyyy<cr><lf>	Returns the date of manufacture
Error?	<sp> text message <cr><lf>	Returns the next error in the error queue
Errorno?	<sp>Enn-text<cr><lf>	Returns pcs400 error code and text
Filter	Off, Low, Normal, High	Sets the reading filter 0, 80%, 92%, 95%
Filter?	<sp> (filter)<cr><lf>	Returns the reading filter
Gateway	nnn.nnn.nnn.nnn	Sets the Ethernet gateway address
Gateway?	<sp>nnn.nnn.nnn.nnn<cr><lf>	Gets the Ethernet gateway address
Id?	<sp> MENSOR, CPA8001, ssssss,v.v.vv <cr><lf>	Ssssss is the serial number,v.vv is the CPA8001 software version
IP	nnn.nnn.nnn.nnn	Sets the IP address of the instrument
IP?	<sp>nnn.nnn.nnn.nnn<cr><lf>	Returns the IP address of the instrument
Keylock	Yes or No	Locks or unlocks keyboard
Keylock?	<sp>(yes or no)<cr><lf>	Returns Yes or No
List?	<sp>Pri,X,X;Sec,X,X;Bar,1<cr><lf>	Returns available channels “PS, QC, PT”
Listcal?	<sp>PRI,{sn},{td},{mmdyy};{BAR,{sn},{td},{mmdyy}}<cr><lf>	Returns the calibration dates of the installed transducer for the active channel. Channel A (Ps) will respond with barometer information when present.

Listrange?	<sp>PRI,1,min,max,2,min,max;{BAR,1,min,max}	Returns the ranges of the installed transducers for the active channel
Locale?	<sp>ll_CC<cr><lf>	Returns the posix locale of the instrument
Loudness	<n>	Sets speaker volume, where <n> is an integer 0...100
Loudness?	<n>	Returns speaker volume
LowerLimit	Value greater or equal to min. sensor range, less than upper limit in current units.	Sets the lower control limit for the instrument
LowerLimit?	<sp>xxxxxxx<cr><lf>	Returns the lower control limit for the instrument in current units
Measure	none	Instrument placed in Measure Mode
Measure?	<sp>(yes or no)<cr><lf>	Returns YES if instrument is in measure. No if otherwise
Mode	Standby, measure, control, vent	Sets the operation mode of the active channel
Mode?	<sp>Xxxxxx<cr><lf>	Returns the operation mode of the active channel
Netmask	nnn.nnn.nnn.nnn	Sets the Ethernet network mask
Netmask?	<sp>nnn.nnn.nnn.nnn<cr><lf>	Gets the Ethernet network mask
Options?	<sp>o[,0[,0...]]<cr><lf>	Returns list of installed options
Outform	1 to 8 – see table below	Sets the output format
Outform?	<sp>X<cr><lf>	Returns the output format – see table below
Peakmax?	<sp>n.nnnnne+nn<cr><lf>	Returns the maximum pressure since peakreset was sent
Peakmin?	<sp>n.nnnnne+nn<cr><lf>	Returns the minimum pressure since peakreset was sent
Peakreset		Resets the peak values
Percent	Value in percent	Sets an exact measure filter percent
Percent?	<sp>n.nnnnne+nn<cr><lf>	Returns the filter percent
Port	nnnnnn	Sets the Ethernet port of the instrument
Port?	<sp>nnnnn<cr><lf>	Returns the Ethernet port of the instrument
Precision		Sets the active channel to the precision mode: .003% stable window and 4 second stable delay.
Ptype	Absolute or gauge	Sets the instrument pressure type – gauge only works if the optional barometric sensor is installed
Ptype?	<sp>CCCCC<cr><lf>	Returns “Absolute” or “Gauge” for the pressure type
RangeMax?	<sp>XXXXXXX<cr><lf>	Returns the maximum range of the active transducer and turndown in the current units

RangeMin?	<sp>XXXXXXX<cr><lf>	Returns the minimum range of the active transducer and turndown in the current units
Rate?	<sp>XXXXXXX<cr><lf>	Returns the rate reading of the instrument in current units/second
Rdecpt?	<sp>n<cr><lf>	Returns the number of rate decimal points for the active channel. (see Resolution)
Reference	{EXTVAC or ATM}	Sets the reference type for vacuum pump connected to the reference, or vented to atmosphere. This option is available only on native gauge units.
Reference?	<sp>{EXTVAC or ATM}<cr><lf>	Returns the current reference type of the active channel. See: Reference
Release?	15 char string. Ex: Release? Test_stand_1  Returns: <sp>(YES or NO), CCC...CCCcr><lf>	This command is used to release control of the instrument in a multiple computer environment.  Yes if release is successful  No if instrument is being controlled with another computer  CCC... = name of controlling computer or AVAILABLE  See: Acquire? and Unlock
Repeat		Repeats output continually over serial port.
Resolution	n	Sets the number of significant digits. See decpt
Resolution?	<sp>n<cr><lf>	Returns the number of significant digits. See decpt.
Rfilter	Value in %	Sets the % of the rate filter
Rfilter?	<sp>n.nnnnne+nn<cr><lf>	Returns the rate filter.
Rsetpt	Value in current units	Sets the rate setpoint
Rsetpt?	<sp>n.nnnnne+nn<cr><lf>	Returns the rate setpoint
Rfreq	Value in frequency	Sets rate Butterworth corner frequency
Rfreq?	<sp>n.nnnnne+nn<cr><lf>	Returns rate Butterworth corner frequency
Rwindow	Value in current units	Sets rate exponential filter window
Rwindow?	<sp>n.nnnnne+nn<cr><lf>	Returns rate exponential filter window
Sbaud	9600, 19200, 38400, 57600	Sets the serial baud rate
Sbaud?	<sp>XXXX<cr><lf>	Returns the serial baud data
Sdata	7 or 8	Sets the serial data bits
Sdata?	<sp>X<cr><lf>	Returns the serial data bits number
Sensor	C, X	Sets the active transducer where C = Primary and X = Turndown. Note: All ADTS channel only have a Primary sensor, and all sensors only have 1 turndown, so this command is trivial

Sensor?	<sp>C,X<cr><lf>	Returns active transducer as above
Sensorid?	<sp>0 ID MENSOR, ADTS_XDC, SSSSSSSS, Vx.xx<cr><lf>	Returns the active sensor's Identification string, including the address, manufacturer, model, serial number, and firmware version. If the sensor does not exist (or is a virtual sensor such as emulated Pt or Qc) a ? is returned. Example// 0 ID MENSOR, ADTS_XDR, 41000CTZ, V5.05
Setpt	Value inside upper and lower limits and inside the range of the active sensor and turndown.	Sets the control setpoint for the instrument
Setpt?	<sp>XXXXXXX<CR><lf>	Returns the control setpoint in current units
Setpt%	Value in % of current range	Sets the control setpoint in % of current range
Setptpct	Value in % of current range	Sets the control setpoint in % of current range
Setptpct?	<sp>n.nnnne+nn<cr><lf>	Returns the current setpoint in % of current range
Span	desired pressure or ?	Sets span on active transducer or for ?, clears previous value, must be > 50% FS and has a 1% limit
Span?	<sp>XXXXXXX<cr><lf>	Returns span scale factor for active transducer
Sparity	Even, ODD, NONE	Sets the serial parity
Sparity?	<sp>CCCC<cr><lf>	Returns the serial parity
Sstop	1 or 2	Sets the serial stop bits
Sstop?	<sp>X<cr><lf>	Returns the serial stop bits
Stable?		Returns YES if instrument is stable or No
Stabledelay	0 to 65535	Sets the stable time to the number of seconds specified
Stabledelay?	<sp>XXXXXXX<cr><lf>	Returns the stable time.
Stabletime	0 to 65535	Sets the stable time to the number of seconds specified
Stabletime?	<sp>XXXXXXX<cr><lf>	Returns the stable time
StableWin	%fs value	Sets the stable window as a %FS for the active transducer and turndown
StableWin?	<sp>XX<cr><lf>	Returns the stable window
Step	Value inside upper and lower control limits and inside the range of the active sensor and turndown.	Sets the control step size for the instrument
Step-	Optional value	Jogs the setpoint down one step
Step+	Optional value	Jogs the setpoint up one step

Step?	<sp>XXXXXXX<cr><lf>	Returns the control step for the instrument
Step%	Value in % of current range	Sets the control step in % of current range
Steppct	Value in % of current range	Sets the control step in % of current range
Steppct?	<sp>n.nnnnne+nn<cr><lf>	Returns the current step in % of current range
Stop		Stop repeating output over serial port - see repeat
Units	units code or text in table below	Sets the active channel's engineering units. See Table 11.4.
Units?	<sp>CCCC<cr><lf>	Returns the active channel's units in a text string.
Unlock	None	Releases Acquire locks See Acquire? And Release?
UpperLimit	Value inside primary xducer-Range on turndown #1 in current units.	Sets the upper control limit for the active transducer
UpperLimit?	<sp>xxxxxxx<cr><lf>	Returns the upper control limit for the active transducer
Vent	None	Instrument placed in Vent Mode
Vent?	<sp>(yes or no)<cr><lf>	Returns yes if instrument is in Vent, no if otherwise
Volume?	<sp>Xxxxxxx<cr><lf>	Returns the current system volume in cc's
Window	Value in current units	Sets the exponential filter window for the active sensor
Window?	<sp>n.nnnnne+nn<cr><lf>	Returns the exponential filter window for the active sensor
Zero	desired pressure or ?	Sets zero to set pressure or for ?, clears previous value
Zero?	<sp>xxxxxxx<cr><lf>	Returns zero offset for active transducer

**8.3 SCPI Commands**

**Table 8.3 - SCPI Commands**

Command		Function
<b>MEASure</b>		
[:PRESsure] [R]?		Returns the reading from range R in current engineering units.
:TEMPerature[R]?		Returns the temperature from range R
:RATE[R]?		Returns the pressure rate/sec from range R
:BAROmetric?		Returns the barometric pressure
:SLEW?		Returns the rate/min
<b>CALibration</b>		
[:PRESsure][R]		
	:MODE?	Returns 1=calibrated or 0=not calibrated
	:DATE?	Returns date of cal "DD,MM,YY"
	:DATE <i,i,i>	Sets date of cal YYYY,MM,DD
	:ZERO?	Returns zero offset
	:ZERO <n>	Sets the zero offset
	:ZERO:RUN	Start Autozero sequence
	:ZERO:STOP	Stop autozero sequence
	:ZERO:INITiate?	Returns zero status
	:ZERO:INITiate	Ignored
<b>SENSE</b>		
[:PRESsure] [R]		
	:NAME?	Returns transducer name string
	:MODE?	Returns pressure type "ABSOLUTE" or "GAUGE"
	:MODE ABS/GAUGE	Sets the pressure type to absolute or gauge
	:ABS?	Returns native transducer type "1" for absolute, "0" for gauge
	:RESolution?	Returns resolution (float)
	:RANGe	
		[:UPPer]?
		:LOWer?
	:UNIT	
		[:NAME]?
		:VALue?
<b>SYSTem</b>		
:DATE <i,i,i>		Sets the system date YYYY,MM,DD



:DATE?		Returns system date YYYY,MM,DD
:TIME <i,i,i>		Sets the system time HH,MM,SS
:TIME?		Returns system time HH,MM,SS
:ERRor[:NEXT]?		Return error code, description
:KLOCK ON/ OFF/1/0		Lock or unlock keyboard
:PRESet		Load known values
:SAVe		no function (not needed)
:VERsion?		Return SCPI version 1994.0.
<b>TEST</b>		
:ELECTronic?		Returns "OK".
:RELay <n>?		Returns status of digital output <n> ignored
:RELay <n> ON/ OFF		Turns the digital output on or off <n> ignored
<b>UNIT</b>		( Note: see <a href="#">Table 11.2 - Conversion Factors, bar</a> )
:PREsSure<n>		Sets the pressure units
:PREsSure?		Returns the pressure units
:NAME<n>?		Returns the units string for units code <n>
:FACTor<n>?		Returns the units conversion for units code <n>
[:PREsSure] bar/ mbar/Pa/PSI		Sets the global remote unit by unit name
:INDEX <n>		Sets the global remote unit by index number

:INDEX?		<p>Index Unit</p> <p>0 bar</p> <p>1 mbar</p> <p>2 Pa</p> <p>3 psi</p> <p>4 atm</p> <p>5 kp/cm<sup>2</sup></p> <p>6 lbf/ft<sup>2</sup></p> <p>7 kPa</p> <p>8 cmH<sub>2</sub>O(4°C)</p> <p>9 inH<sub>2</sub>O(4°C)</p> <p>10 inH<sub>2</sub>O(20°C)</p> <p>11 inH<sub>2</sub>O(60°F)</p> <p>12 ftH<sub>2</sub>O(4°C)</p> <p>13 mmHg(0°C)</p> <p>14 cmHg(4°C)</p> <p>15 inHg(0°C)</p> <p>16 inHg(60°F)</p> <p>17 --</p> <p>18 user</p> <p>19 user</p> <p>20 user</p>
<b>OUTPut</b>		
:STATe ON/ OFF/1/0		ON or 1 = control OFF or 0 = measure
:STATe?		Returns 0 for measure 1 for control
:MODE MEASure/ CONTrol/VENT		Sets the mode indicated
:MODE?		Returns the mode string
:STABle?		Returns 1 if stable 0 if not
<b>[SOURce]</b>		
:PRESsure		
	[:LEVel]	
		[:IMMediate]

			[:AMPLitude] <n>	Sets the setpoint
			[:AMPLitude]?	Returns the setpoint
	:SLEW <n>			Sets the slew rate setpoint
	:SLEW?			Returns the slew rate setpoint
	:TOLerance <n>			Sets the stable window
	:TOLerance?			Returns the stable window
<b>CALCulate</b>				
:LIMit				
	:LOWer<n>			Sets minimum control limit
	:LOWer?			Returns minimum control limit
	:UPPer<n>			Sets maximum control limit
	:UPPer?			Returns maximum control limit

**8.4 SCPI Error Messages and Error Codes**

A recognized command is displayed at the device in the headline with “Remote...”. In case of error “Remote error...” is displayed. A maximum of 100 errors are stored and can be retrieved successfully.

**Table 8.4 - Error Messages and Error Codes**

<b>Code</b>	<b>Error String Returned</b>
0	No error
-101	Undefined character
-102	Syntax error
-103	Undefined separator
-104	Parameter data type error
-109	Parameter missing
-110	Undefined header
-113	Undefined command
-114	Parameter out of range
-313	Calibration data not found
-315	Configuration data not found
-350	Errorqueue overflow
-410	Query interrupted
600	Default configuration not found
601	Calibration mode active! Deactivate before setting C0..C3
602	Transducer not available
701	DCS instance not available
702	Create DCS instance failed
703	DCS still active
704	Command currently not allowed

## 9. Options

This section lists options available for the CPA8001. Users might consider letting the factory install a special feature not listed here. Mensor welcomes the opportunity to quote on such requests. The cost of adding an enhancement frequently will amortize itself in a very short time because of improved process efficiency.

### 9.1 Transport Case

A wheeled transport case is available suitable for moving the CPA8001 between sites, or as an air-freight (or other) shipping container. The case is constructed of a high impact plastic with a black exterior. It includes two keys, locks, a piano hinge, an anodized interlocking tongue and groove opening, various nickel-chrome and stainless steel fixtures, a vinyl satchel style handle and a retractable pull-out handle. The interior is filled with high density polyurethane foam with a die-cut cavity to cradle the instrument with fitting adapters in place, and an additional cavity to store related accessories. Rugged and weather resistant, the case makes an attractive, practical shipping and moving container. The case weighs approximately 29 pounds (13.15 kg) unloaded, and can support a load of up to 150 pounds (68.04 kg). Nominal dimensions are 15 inches by 24 inches by 26 inches (38.10 cm x 60.96 cm x 66.04).

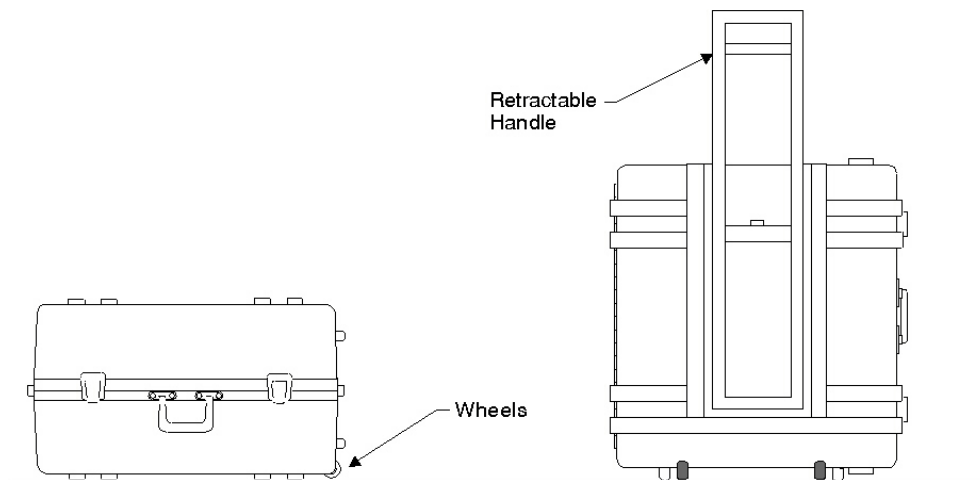

Figure 9.1 - Transport Case

### 9.2 Rack Mount Kit

This kit provides the materials and instructions necessary for the user to convert a desk top CPA8001 for installation into a standard 19" rack.

### 9.3 Barometric Reference Transducer

A removable interchangeable barometer is available for use as an atmospheric pressure reference. The barometric reading can be used to calculate QNH - "barometric pressure adjusted to sea level."

### 9.4 Adaptor Fittings

- 1/4 in. Tube OD x 7/16-20 Male SAE/MS Straight Thread
- 6 mm Tube OD x 7/16-20 Male SAE/MS Straight Thread

- AN4 x 7/16-20 Male SAE/MS Straight Thread or AN6 x 7/16-20 Male SAE/MS Straight Thread

## **10. Maintenance**

The CPA8001 was designed for maintenance-free operation. User maintenance is not recommended. If you have questions not covered by this manual, call 1.800-984-4200 (USA only), or 1-512-396-4200 for assistance or send an email to tech.support@mentor.com.

### **10.1 Beyond the Warranty**

Take advantage of Mensor's expert product care. Mensor provides complete maintenance and calibration services, available for a nominal fee. Our service staff is knowledgeable in the innermost details of all of our instruments. We maintain units that are in operation in many different industries and in a variety of applications, and by users with a wide range of requirements. Many of our instruments have been in service for decades, and continue to produce excellent results.

Returning your instrument to Mensor for service benefits you in several ways:

- Our extensive knowledge of the instrument assures you that it will receive expert care.
- In many cases we can economically upgrade an older instrument to the latest improvements.
- Servicing our own instruments which are used in "real world" applications keeps us informed as to the most frequent services required. We use this knowledge in our continuing effort to design better and more robust instruments.

### **10.2 Troubleshooting**



**ESD PROTECTION REQUIRED!** The proper use of grounded work surfaces and personal wrist straps are required when coming into contact with exposed circuits (printed circuit boards) to prevent static discharge damage to sensitive electronic components.



Warning



**WARNING!** If faults cannot be corrected locally, immediately take the system off line and protect it from unintentional restarts. Contact Mensor Customer Service for further instructions. Apparent problems are frequently resolved over the telephone by our staff.

**Do not risk voiding the warranty. Higher level repairs must be carried out exclusively by or personnel, or under Mensor supervision.**

**Servicing of electrical, electronic, pneumatic or hydraulic equipment must be**

performed by qualified and authorized technical staff, observing all relevant safety regulations.

Table 10.2 - Troubleshooting

Type	Problem	Correction Action
1	The system has been switched on and no measurement(s) have appeared and the entire area of the screen is white (or dark).	Switch the system off. Wait 5 seconds and switch the system on.
2	The screen is dark and the corrective action for #1 above has no effect	Check that the power cable is connected properly and have authorized technical staff check that the supply voltage is correct.
3	The screen is dark and the action taken to solve the problem of #2 above has no effect.	<p>Unplug the unit from the power source (wall socket), then remove the power cord from the instrument. The power cord input socket includes two internal fuses. Check both fuses for continuity.</p> <div style="text-align: center;">  <p>Fuse holder</p> <p>Power cord input socket</p> </div> <div style="text-align: center;">  <p>Warning</p> <p><b>WARNING! When needed, use only 2.5 amp 250V SLO-BLO 5x20 Fuse</b></p> </div>
4	Malfunction during operation.	Switch the system off. Wait 5 seconds and switch the system on.
5	Unstable control.	Consult factory
6	The setpoint value is not reached.	Check whether the value of the supply pressure is the value required, and leak test the plumbing.

If you need help or assistance, contact Mensor at

Phone: 1-512-396-4200 or 1-800-984-4200 (USA only)  
 Fax: 512-396-1820  
 Email: sales@mensor.com  
 tech.support@mensor.com  
 Website: www.mensor.com

### 10.2.1 Pressure Transducer Location

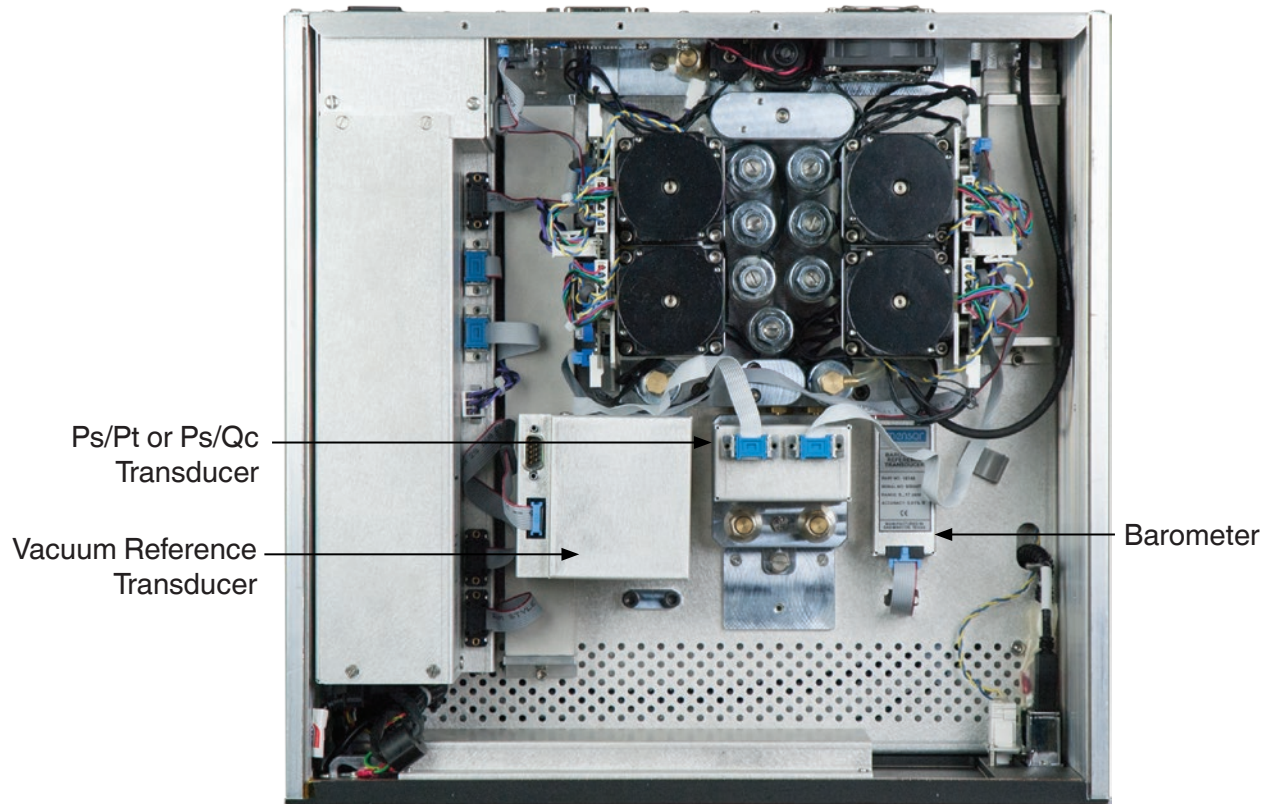

Figure 10.2.1 - Top View

### 10.2.2 Transducer Removal / Replacement



Figure 10.2.2 - Front View, Panel Open

The front panel is hinged to allow access to the self-contained pressure transducer. To open the front panel, first turn off system power, then loosen the captive screws near the right hand edge of the panel. The panel can then swing away to reveal the transducers lined up across the interior.



**If the system has not been powered down, opening the front panel will trip an interlock to vent the system to atmosphere.**

Notice





**CAUTION:** Further access to the interior of the instrument is **NOT** recommended. There are no user-serviceable plumbing or parts inside. In addition to the dangerous voltages present (line voltage), there are circuits sensitive to electrostatic discharge damage. There are also several solenoid valves which will run hot enough to cause painful burns under certain operating conditions. These dangerous conditions will be avoided by limiting interior access to the areas that are exposed by opening the front panel.

To remove a transducer from the system, swing the front panel open and disconnect the 9-pin D-sub connector from its top. Then the thumb screw near the base of the transducer. Lift and slide the transducer toward the front opening to disconnect it from the manifold. If an optional Barometric transducer is present it will occupy a slot to the far right and will be secured in place with a thumb screw. Loosen the thumb screw and lift the transducer up and over the retaining pin. Each pressure or barometer module is totally self-contained and including the pressure transducer and all of its calibration data.

To return the module, or a replacement module to the system slide it firmly back into position to engage the pneumatic passages with those in the manifold, tighten the thumb screw, and connect the communication/power D-sub connector. To replace the optional barometer, slide it back into place over the retaining pin and tighten the thumb screw. Finally, secure the front panel and test that the system is operational.

### 10.2.3 Side Panel Removal

On desk-top units the two identical side panels include formed recesses which are used as lift points to move or carry the instrument over short distances. These side panels are secured to the chassis by three 3mm Allen cap screws accessible inside the lift-recesses. With the cap-screws removed pull the side panel straight out away from the chassis with enough force to overcome the friction pins which hold it in position.

## **11. Appendix**

### **11.1 Avionics Overview**

The CPA8001 is a precision Air Data Test Set (ADTS) intended for use in the calibration of altimeters, airspeed indicators and air data computers. In order to understand and use the ADTS an operator should have a basic understanding of air data instruments and terminology. The following is a brief guide to terminology and the physical characteristics of air data components.

#### **Ps-Altitude:**

Ps stands for Static Pressure. Static pressure is an absolute pressure that is the atmospheric pressure unaffected by movement of the surrounding air at any given location within earth's atmosphere. It has a nonlinear inverse relationship to altitude. As altitude increases, static pressure decreases. This relationship has been defined in the "US Standard Atmosphere". The equations used in the Mensor CPA8001 are based on this document.

#### **Ps-Rate:**

Ps-Rate is the Static Pressure rate of change.

#### **Pt-Total Pressure:**

Total Pressure is the pressure that results from the existing barometric pressure in addition to the force of the moving airstream against the aircraft as it flies. This force is sensed using a pitot tube facing into the airstream.

#### **Pt-Rate:**

Pt-Rate is the Total Pressure rate of change.

#### **Qc-Airspeed:**

Qc-Airspeed is defined as the difference between Total Pressure (Pt) and the Static Pressure (Ps). This is the pressure due to the impact of the air relative to the motion of the aircraft and is equated to airspeed using formulas derived from the "US Standard Atmosphere".

$$Qc = Pt - Ps$$

#### **Qc-Airspeed Rate:**

Qc-Airspeed Rate is the rate of change of airspeed (acceleration).

#### **Pitot Tube:**

A Pitot Tube is a sensing element for the Static (Ps) and Total Pressure (Pt) experienced by an aircraft as it moves through the atmosphere. The diagram below is a simple representation of a pitot tube and shows how Ps, Pt and Qc are sensed.

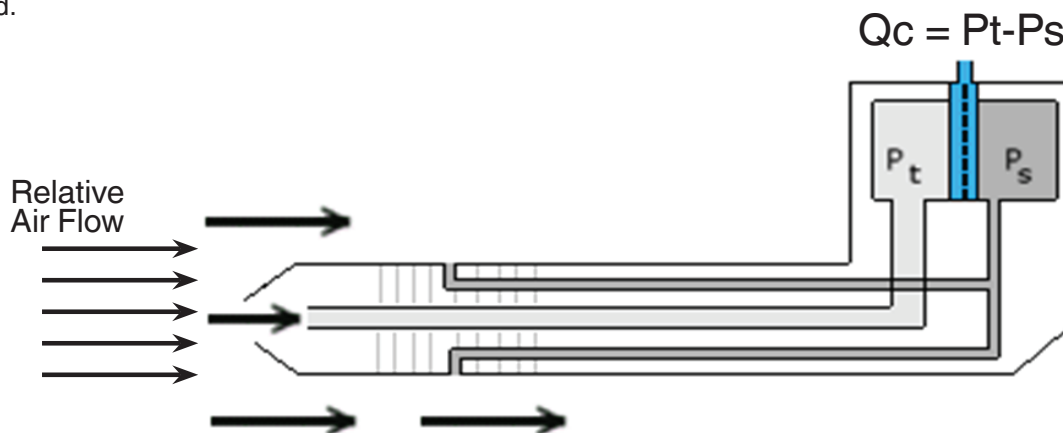

#### **Altimeters, airspeed indicators and air data computers:**

Ultimately an instrument is connected to the pitot tube to measure the Altitude (Ps) and Airspeed (Qc) or there are pressure transmitters incorporated within the pitot tube. The CPA8001 is designed to simulate the output from a pitot tube and calibrate these instruments.

## 11.2 Measurement Units

The Units command selects the measurement units to be output on the bus and the display.

**Table 11.2 - Measurement Units**

Description	Output format
psi	psi
bar	bar
millibar	mbar
hectopascals	hPa
kilopascals	kPa
kilogram per centimeter squared	kg/sq cm
inches of mercury @0 degrees Celcius	inHg @0C
inches of water @4 degrees Celcius	inH2O @4C
inches of water @20 degrees Celcius	inH2O @20C
inches of water @60 degrees Ferenheit	inH2O @60F
feet of water @4 degrees Celcius	ftH2O @4C
feet of water @20 degrees Celcius	ftH2O @20C
feet of water @60 degrees Ferenheit	ftH2O @60F
millimeters of mercury @0 degrees Celcius	mmHg @0C
millimeters of water @4 degrees Celcius	mmH2O @4C
millimeters of water @20 degrees Celcius	mmH2O @20C
centimeters of mercury @0 degrees Celcius	cmHg @0C
centimeters of water @4 degrees Celcius	cmH2O @4C
centimeters of water @20 degrees Celcius	cmH2O @20C
ounce per square inch	oz/si
psf	psf
tons per quare inch	tons/sq in
tons per square foot	tons/sq ft
inches of sea water	inSW
feet of sea water	ftSW
inches of mercury @ 60 degrees Feihrenheit	inHg @60F
torr	Torr
millitorr	mTorr
microns of mercury @0 degrees Celcius	micronHg @0C
millimeters of mercury @0 degrees Celcius	mmHg @0C
centimeters of mercury @0 degrees Celcius	cmHg @0C
meter of mercury @0 degrees Celcius	mHg 0C
meters of water @20 degrees Celcius	mH2O @20C
meters of water @4 degrees Celcius	mH2O @4C
meters of sea water	mSW
grams per centimeter squared	g/cm <sup>2</sup>
kilogram per meters squared	kg/m <sup>2</sup>

pascals	Pa
megapascals	MPa
dynes per centimeter squared	dyn/cm <sup>2</sup>
percent full scale	% FS
User 1	User 1
User 2	User 2

### 11.3 Conversion Factors, bar

The following table lists factors which should be used as multipliers when converting other pressure units to or from bar.

**Table 11.3 - Conversion Factors, bar**

ID	Name	Unit	p [bar] / p [Unit]	p [Unit] / p [bar]
0	bar	bar	1.000000E+00	1.000000E+00
1	Millibar	mbar	1.000000E-03	1.000000E+03
2	Pascal	Pa	1.000000E-05	1.000000E+05
3	pound-force / inch <sup>2</sup>	psi	6.894757E-02	1.450377E+01
4	standard atmosphere (760 Torr)	atm	1.013250E+00	9.869233E-01
5	Technical atmosphere	kp/cm2	9.806650E-01	1.019716E+00
6	pound-force / foot <sup>2</sup>	lbf/ft2	4.788026E-04	2.088543E+03
7	kilopascal	kPa	1.000000E-02	1.000000E+02
8	Centimetres water column 4°C	cmH2O (4°C)	9.806380E-04	1.019744E+03
9	Inch water column 4°C	inH2O (4°C)	2.490820E-03	4.014742E+02
10	Inch water column 20°C	inH2O (20°C)	2.486400E-03	4.021879E+02
11	Inch water column 60°F	inH2O (60°F)	2.488400E-03	4.018647E+02
12	Feet water column 4°C	ftH2O (4°C)	2.988980E-02	3.345623E+01
13	Millimeter mercury column 0°C (Torr)	mmHg (0°C)	1.333224E-03	7.500615E+02
14	Centimetres mercury column 4°C	cmHg (4°C)	1.333224E-02	7.500615E+01
15	Inch mercury column 0°C	inHg (0°C)	3.386380E-02	2.953006E+01
16	Inch mercury column 60°F	inHg (60°F)	3.376850E-02	2.961340E+01
17	--			
18	user			
19	user			
20	user			

### 11.4 Conversion Factors, PSI

The following table lists factors which should be used as multipliers when converting other pressure units to or from psi.

**Table 11.4 - Conversion Factors, psi**

Pressure unit	To convert from PSI	To convert to PSI
psi	1	1
bar	0.06894757	14.50377
mbar	68.94757	0.01450377
hPa	68.94757	0.01450377
kPa	6.894757	0.1450377
kg/sq cm	0.07030697	14.22334
inHg @0C	2.036020	0.4911544
inH2O @4C	27.68067	0.03612629
inH2O @20C	27.72977	0.03606233
inH2O @60F	27.70759	0.03609119
ftH2O @4C	2.306726	0.4335149
ftH2O @20C	2.310814	0.4327480
ftH2O @60F	2.308966	0.4330943
mmHg @0C	51.71508	0.01933672
mmH2O @4C	703.0890	0.001422295
mmH2O @20C	704.336	0.001419777
cmHg @0C	5.171508	0.1933672
cmH2O @4C	70.30890	0.01422295
cmH2O @20C	70.4336	0.01419777
oz/si	16	0.0625
psf	144	0.006944444
tons/sq in	0.0005	2000
tons/sq ft	0.072	13.88889
inSW	26.92334	0.03714250
ftSW	2.243611	0.445710
inHg @60F	2.041772	0.4897707
Torr	51.71508	0.01933672
mTorr	51715.08	0.00001933672
micronHg @0C	51715.08	0.00001933672
mmHg @0C	51.71508	0.01933672
cmHg @0C	5.171508	0.1933672
mHg 0C		
mH2O @20C	0.704336	1.419777
mH2O @4C	0.7030890	1.422295
mSW	0.6838528	1.462303
g/cm <sup>2</sup>	70.30697	0.01422334

kg/m <sup>2</sup>		
Pa	6894.757	0.0001450377
MPa	0.006894757	145.0377
dyn/cm <sup>2</sup>	68947.57	0.00001450377
% FS	(PSI / RANGE) x 100	(% FS x RANGE) / 100
USER 1		
USER 2		

### 11.5 Conversion Factors, millitorr

The following table lists factors which should be used as multipliers when converting other pressure units to or from millitorr.

**Table 11.5 - Conversion Factors, millitorr**

<b>Code</b>	<b>Pressure unit</b>	<b>To convert from millitorr</b>	<b>To convert to millitorr</b>
1	psi	0.00001933672	51715.08
2	inHg @0C	0.00003936995	25400.08909
3	inHg @60F	0.00003948117	25328.53093
4	inH2O @4C	0.0005352534	1868.273977
5	inH2O @20C	0.0005362028	1864.966281
6	inH2O @60F	0.0005357739	1866.458778
7	ftH2O @4C	0.00004460451	22419.25773
8	ftH2O @20C	0.00004468356	22379.59744
9	ftH2O @60F	0.00004464783	22397.50637
10	mTorr	1.0	1.000000000
11	inSW @0C 3.5% salinity	0.0005206091	1920.827359
12	ftSW @0C 3.5% salinity	0.00004338408	23049.92831
13	atm	0.000001315786	760002.2299
14	bar	0.000001333220	750063.6259
15	mbar	0.001333220	750.0636259
16	mmH2O @4C	0.0135954	73.5540997
17	cmH2O @4C	0.001359544	735.5409971
18	mH2O @4C	0.00001359544	73554.09971
19	mmHg @0C	0.001	1000.000000
20	cmHg @0C	0.0001	10000.00000
21	Torr	0.001	1000.000000
22	kPa	0.0001333220	7500.636259
23	Pa	0.1333220	7.500636259
24	dyn/sq cm	1.333220	0.750063626
25	g/sq cm	0.001359506	735.561166
26	kg/sq cm	0.000001359506	735561.166
27	mSW @0C 3.5% salinity	0.00001322347	75623.11663
28	oz/si	0.0003093875	3232.1992
29	psf	0.002784488	359.132477
30	tons/sq ft	0.000001392244	718265.0575
32	micronHg @0C	1.0	1.000000000
33	tons/sq in	0.00000000966836	103430160.00
35	hPa	0.001333220	750.0636259
36	MPa	0.0000001333220	7500636.259
37	mmH2O @20C	0.01361955	73.42388114
38	cmH2O @20C	0.001361955	734.2388114
39	mH2O @20C	0.00001361955	73423.88114



**Mensor**

201 Barnes Drive  
San Marcos, Texas 78666  
Tel. 512-396-4200  
Fax 512-396-1820  
sales@mensor.com  
www.mensor.com



**WIKA Alexander Wiegand SE & Co. KG**

Alexander-Wiegand-Straße 30  
63911 Klingenberg / Germany  
Tel. +49 9372/132-5015  
Fax +49 9372/132-8767  
CTSales@wika.de  
www.wika.de